



Requirements for Flood Openings in Foundation Walls and Walls of Enclosures

Below Elevated Buildings in Special Flood Hazard Areas
In Accordance with the National Flood Insurance Program

NFIP Technical Bulletin 1 / March 2020



FEMA

Comments on the Technical Bulletins should be directed to:

Department of Homeland Security / Federal Emergency Management Agency
Federal Insurance and Mitigation Administration (FIMA) Risk Management Directorate
Building Science Branch
400 C Street, S.W., Sixth Floor
Washington, DC 20472-3020

NFIP Technical Bulletin 1 (2020) replaces NFIP Technical Bulletin 1 (2008), *Openings in Foundation Walls and Walls of Enclosures*.

Photograph credits:

Cover: Leigh Chapman, Salters Creek Consulting

Figure 3. Bill Bryant, Anne Arundel County, Maryland

Figure 17. North Carolina Emergency Management/T. Riddle

NFIP Technical Bulletin 1 contains information that is proprietary to and copyrighted by the American Society of Civil Engineers and information that is proprietary to and copyrighted by the International Code Council, Inc. All information is used with permission.

For more information, see the FEMA Building Science Frequently Asked Questions website at <http://www.fema.gov/frequently-asked-questions-building-science>.

If you have any additional questions on FEMA Building Science Publications, contact the helpline at FEMABuildingsciencehelp@fema.dhs.gov or 866-927-2104.

You may also sign up for the FEMA Building Science email subscription, which is updated with publication releases and FEMA Building Science activities. Subscribe at <https://public.govdelivery.com/accounts/USDHSFEMA/subscriber/new>.

Visit the Building Science Branch of the Risk Management Directorate at FEMA's Federal Insurance and Mitigation Administration at <https://www.fema.gov/building-science>.

To order publications, contact the FEMA Distribution Center:

Call: 1-800-480-2520

(Monday–Friday, 8 a.m.–5 p.m., EST)

Fax: 719-948-9724

Email: FEMApubs@gpo.gov

Additional FEMA documents can be found in the FEMA Library at <https://www.fema.gov/media-library/>.

Please scan this QR code to visit the FEMA Building Science web page.



Table of Contents

Acronyms.....	iv
1 Introduction.....	1
2 National Flood Insurance Program Regulations.....	3
3 Building Codes and Standards.....	5
3.1 International Residential Code.....	5
3.2 International Building Code and ASCE 24.....	6
4 NFIP Flood Insurance Implications.....	8
5 Documenting Building Elevations and Flood Openings Using the NFIP Elevation Certificate	8
6 Use of Enclosed Areas Below Elevated Buildings	9
7 Foundation Walls and Enclosure Walls that Require Flood Openings	10
7.1 Solid Perimeter Foundation Walls (Crawlspaces and Under-Floor Spaces)	11
7.2 Solid Perimeter Foundation Walls (Below-Grade Crawlspaces)	12
7.3 Garages Attached to Elevated Buildings	13
7.4 Enclosed Areas Under Buildings Elevated on Open Foundations	14
7.5 Enclosed Areas with Breakaway Walls Under Buildings Elevated on Open Foundations	15
7.6 Above-Grade (Elevated) Enclosed Areas.....	16
7.7 Two-Level Enclosed Areas	17
7.8 Solid Perimeter Foundation Walls on which Manufactured Homes Are Installed	18
7.9 Accessory Structures	19
8 Requirements and Guidance for Installation of Flood Openings.....	20
8.1 Location and Minimum Number of Flood Openings.....	20
8.2 Height of Flood Openings Above Grade or Floor	21
8.3 Examples of Flood Opening Installations.....	22
8.3.1 Interior Grade or Floor Higher than the Exterior Grade	22
8.3.2 Sloping Sites.....	23
8.3.3 Buildings with Large Enclosed Areas.....	24
8.3.4 Townhouses with Limited Exterior Walls	24

8.3.5	Buildings with Multiple Enclosures.....	25
8.3.6	Flood Openings in Areas with Shallow Flooding.....	26
9	Non-Engineered Flood Openings and Engineered Flood Openings.....	27
9.1	Measures Not Acceptable as Flood Openings.....	28
9.2	Non-Engineered Flood Openings.....	28
9.3	Engineered Flood Openings.....	33
9.3.1	Design and Performance Requirements.....	33
9.3.2	Documentation of Engineered Openings for Compliance.....	36
9.3.3	Engineered Openings with Certification Reports.....	36
9.3.4	Engineered Openings Individually Certified for Specific Buildings.....	37
9.3.5	NFIP Elevation Certificate and Documentation of Engineered Openings for Flood Insurance.....	39
10	References.....	41

List of Figures

Figure 1:	Equalizing flood forces (hydrostatic loads) on exterior walls.....	1
Figure 2:	Typical enclosures with flood openings in Zone A.....	2
Figure 3:	Full-height, solid perimeter walls surrounding a garage and storage area with flood openings.....	11
Figure 4:	Backfilled stem wall foundation; flood openings not required.....	12
Figure 5:	Limitations on below-grade crawlspaces in shallow flood hazard areas.....	13
Figure 6:	Engineered openings in garage doors.....	14
Figure 7:	Enclosure with flood openings under a house elevated on pilings.....	15
Figure 8:	Above-grade enclosures.....	17
Figure 9:	Two-level enclosure with non-load-bearing walls under building elevated on pilings or columns; configuration also applies if walls are load-bearing.....	18
Figure 10:	Manufactured home supported on interior piers and masonry perimeter wall with flood openings.....	19
Figure 11:	Foundation plan of home with multiple enclosed areas, each with flood openings.....	21
Figure 12:	Manufactured home installed on columns above a full-height, framed garage (note elevation of thick driveway slab on left; the flood openings are within 1 foot of interior floor surface).....	22
Figure 13:	Flood openings in enclosure walls on a sloping site.....	23
Figure 14:	Flood openings that are stacked and closely grouped to satisfy the required total net open area.....	24

Figure 15: Suggested flood openings in enclosures under elevated townhouses25

Figure 16: Bottom of the flood opening positioned as close as possible to grade (or floor) when any portion of the opening extends above the BFE.....26

Figure 17: Standard air vent that is unacceptable as a flood opening because it is not disabled in the open position.....28

Figure 19: Example of non-engineered opening: Typical standard air vent with fixed, angled blades providing approximately 44 square inches of net open area; measurement of net open area uses slot width of 13 inches times the sum of the spaces between the blades29

Figure 18: Example of non-engineered opening: Typical standard air vent faceplate providing 42 square inches of net open area if disabled in the open position; measurement of net open area uses a slot width of 0.5 inch times a slot height of 0.65 inch times the total number of slots29

Figure 20: Typical air vents with insect screens blocked by flood debris.....30

Figure 21: Examples of typical air vents in crawlspace foundation walls used as flood openings with varying net open areas 31

Figure 22: Decorative masonry units and closely spaced holes in brickwork; the area of each hole counts toward the total net open area32

Figure 23: Concrete blocks turned sideways with insect screening; a typical 8- by 16-inch block provides approximately 60 square inches of net open area.....32

Figure 24: Wood frame with insect screen inserted in void in poured concrete foundation wall; inside dimensions of frame determine net open area33

Figure 25: Equation used to determined total net area of engineered openings.....34

Figure 26: Completing the NFIP Elevation Certificate when engineered openings are used40

List of Tables

Table 1: Comparison of Selected 2018 IRC and NFIP Flood Opening Requirements6

Table 2: Comparison of Selected 2018 IBC and ASCE 24-14 Flood Opening Requirements with NFIP Requirements.....7

Table 3: Flood Opening Coefficient of Discharge.....35

Acronyms

ASCE	American Society of Civil Engineers
BFE	base flood elevation
CFR	Code of Federal Regulations
DHS	Department of Homeland Security
FEMA	Federal Emergency Management Agency
FIRM	Flood Insurance Rate Map
IBC	International Building Code®
ICC	International Code Council®
ICC-ES	ICC Evaluation Service
I-Codes	International Codes®
IRC	International Residential Code®
LiMWA	Limit of Moderate Wave Action
NFIP	National Flood Insurance Program
NFPA	National Fire Protection Association
SEI	Structural Engineering Institute
SFHA	Special Flood Hazard Area

1 Introduction

This Technical Bulletin explains the National Flood Insurance Program (NFIP) requirements for flood openings in foundation walls and walls of enclosures below elevated buildings in Special Flood Hazard Areas (SFHAs) that are designated as Zone A (A, AE, A1-30, AH, and AO) on Flood Insurance Rate Maps (FIRMs). The flood opening requirements are intended to equalize hydrostatic forces (loads or pressure caused by standing or slow-moving water) on walls, thus preventing damage to or collapse of the building (see Figure 1). The requirements are not intended to reduce flood damage caused by hydrodynamic loads associated with fast-moving water (e.g., faster than 10 feet per second), wave impacts, or debris impacts.

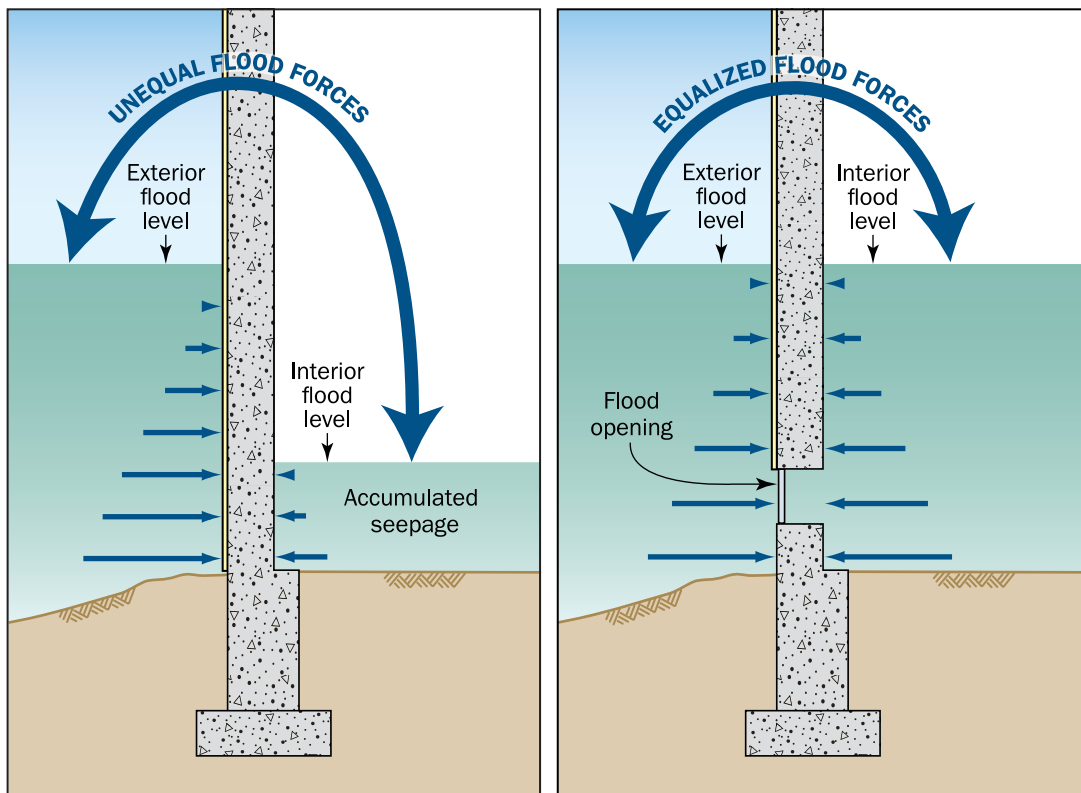

Figure 1: Equalizing flood forces (hydrostatic loads) on exterior walls

This Technical Bulletin includes the following:

- Examples of foundation walls and enclosure walls that require openings. Figure 2 illustrates typical enclosures with flood openings in Zone A: a crawlspace foundation wall, a non-load-bearing wood-framed wall surrounding an enclosed area under a piling- or column-supported building, and a concrete or masonry load-bearing foundation wall surrounding an enclosed area. Other types of enclosures or situations may require the advice of a registered design professional.
- Information on installing flood openings, including the minimum number and minimum height above grade, and examples of installations.

- Guidance on prescriptive (non-engineered) and engineered flood openings. Non-engineered openings do not have moving parts and may be used to meet the NFIP prescriptive requirement for 1 square inch of net open area for every square foot of enclosed area. Engineered openings may be used if designed and certified by a registered design professional as meeting certain performance characteristics.
- Description of how flood openings affect NFIP flood insurance premiums.
- Guidance on documenting building elevations and flood openings using the NFIP Elevation Certificate (FEMA Form 086-0-33) (FEMA, 2015).

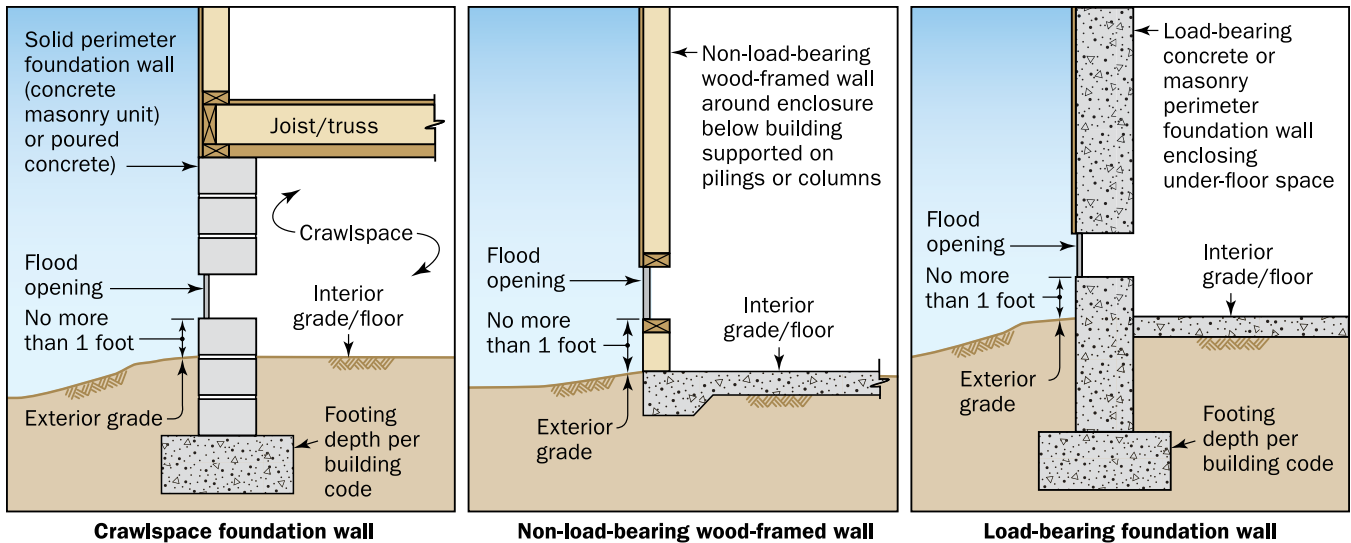

Figure 2: Typical enclosures with flood openings in Zone A

Questions about enclosure and flood opening requirements should be directed to the appropriate local official, NFIP State Coordinating Office, or Federal Emergency Management Agency (FEMA) Regional Office.

NFIP TECHNICAL BULLETIN 0

NFIP Technical Bulletin 0, *User's Guide to Technical Bulletins*, should be used as a reference in conjunction with this Technical Bulletin. Technical Bulletin 0 describes the purpose and use of the Technical Bulletins, includes common concepts and terms, lists useful resources, and includes a crosswalk of the sections of the NFIP regulations identifying the Technical Bulletin that addresses each section of the regulations and a subject index.

Readers are cautioned that the definitions of some of the terms that are used in the Technical Bulletins are not the same when used by the NFIP for the purpose of rating flood insurance policies.

NFIP TERMS USED IN THIS TECHNICAL BULLETIN

- **Basement:** Area of a building that has its floor subgrade (below ground level) on all sides. NFIP regulations do not allow basements to extend below the base flood elevation (BFE) except in dry-floodproofed, non-residential buildings.
- **Enclosed area (enclosure):** An area below an elevated building that is enclosed by walls on all sides.
- **Lowest floor:** Lowest floor of the lowest enclosed area of a building, including basement. An unfinished or flood-resistant enclosure that is used solely for parking of vehicles, building access, or storage is not the lowest floor, provided the enclosure is built in compliance with applicable requirements.
- **Net open area:** Permanently open area of a non-engineered flood opening.
- **Special Flood Hazard Area (SFHA):** Area subject to flooding by the base flood (1-percent-annual-chance flood) and shown on Flood Insurance Rate Maps (FIRMs) as Zone A or Zone V.
- **Zone A:** Flood zones shown on FIRMs as Zone A, AE, A1-30, AH, AO, A99, and AR.
- **Zone V:** Flood zones shown on FIRMs as Zone V, VE, V1-30, and VO.

2 National Flood Insurance Program Regulations

An important NFIP objective is protecting buildings constructed in SFHAs from damage caused by flooding. The SFHA, composed of Zones A and V, is the areal extent of the base flood shown on Flood Insurance Rate Maps (FIRMs) prepared by FEMA. The base flood is the flood that has a 1 percent chance of being equaled or exceeded in any given year (commonly called the “100-year” flood).

The NFIP floodplain management regulations include minimum building design criteria that apply to:

- New construction
- Work determined to be Substantial Improvements, including improvements, alterations, and additions
- Repair of buildings determined to have incurred Substantial Damage

A defining characteristic of the NFIP regulations applicable in Zone A is the requirement for the lowest floor (including basement) to be elevated to or above the BFE. Non-residential buildings in Zone A must be elevated or dry floodproofed. The requirements in Zone V, not addressed in this Technical Bulletin, also specify building elevation, foundation, and enclosure requirements.

Enclosed areas (enclosures) are permitted below elevated buildings if the enclosed areas meet requirements, including limitations on use (parking of vehicles, building access, or storage), use of flood damage-resistant materials, and installation of flood openings that allow automatic entry and exit of floodwater (i.e., free inflow and outflow in both directions) to equalize the hydrostatic flood loads.

The NFIP regulations for enclosures and flood openings are codified in Title 44 of the Code of Federal Regulations (CFR) Part 60. Specific to NFIP Technical Bulletin 1, 44 CFR § 60.3(c)(5) states that a community shall:

Require, for all new construction and substantial improvements, that fully enclosed areas below the lowest floor that are usable solely for parking of vehicles, building access or storage in an area other than a basement and which are subject to flooding shall be designed to automatically equalize hydrostatic flood forces on exterior walls by allowing for the entry and exit of floodwaters. Designs for meeting this requirement must either be certified by a registered professional engineer or architect or meet or exceed the following minimum criteria: A minimum of two openings having a total net area of not less than one square inch for every square foot of enclosed area subject to flooding shall be provided. The bottom of all openings shall be no higher than one foot above grade. Openings may be equipped with screens, louvers, valves, or other coverings or devices provided that they permit the automatic entry and exit of floodwaters.

NFIP REQUIREMENTS AND HIGHER REGULATORY STANDARDS

State or Local Requirements. State or local requirements that are more restrictive or stringent than the minimum requirements of the NFIP take precedence. The Technical Bulletins and other FEMA publications provide guidance on the minimum NFIP requirements and describe best practices. Design professionals, builders, and property owners should contact local officials to determine whether more restrictive requirements apply to buildings or sites in question. All other applicable requirements of state or local building codes must also be met for buildings in flood hazard areas.

Substantial Improvement and Substantial Damage. As part of issuing permits, local officials must review not only proposals for new construction but also for work on existing buildings to determine whether the work constitutes Substantial Improvement or repair of Substantial Damage. If the work is determined to constitute Substantial Improvement or repair of Substantial Damage, the buildings must be brought into compliance with the NFIP requirements for new construction. Some communities modify the definitions of Substantial Improvement and/or Substantial Damage to be more restrictive than the NFIP minimum requirements. For more information on Substantial Improvement and Substantial Damage, see FEMA P-758, *Substantial Improvement/Substantial Damage Desk Reference* (2010), and FEMA 213, *Answers to Questions About Substantially Improved/Substantially Damaged Buildings* (2018).

Elevation Above Minimum NFIP Requirements. Some communities require that buildings be elevated above the NFIP minimum requirement. The additional elevation is called freeboard. Design professionals, builders, and property owners should check with local officials to determine whether a community has freeboard requirements. References to building elevations in this Technical Bulletin should be construed as references to the community's elevation requirement where freeboard is required.

Legal Nonconforming Buildings. Owners of older, legal nonconforming buildings that are elevated with enclosures below the BFE may wish to retrofit the enclosures to conform to current requirements for enclosures, even when the enclosure is below grade on all sides. Lower NFIP flood insurance rates may apply if retrofit enclosures have flood openings that meet the requirements in this Technical Bulletin and other requirements for enclosures (e.g., limited use, flood damage-resistant materials, elevated utilities).

3 Building Codes and Standards

In addition to complying with the NFIP requirements, all new construction, Substantial Improvements, and repair of Substantial Damage must comply with the applicable building codes and standards adopted by states and communities.

The International Codes® (I-Codes®), published by the International Code Council® (ICC®), are a family of codes that includes the International Residential Code® (IRC®), International Building Code® (IBC®), International Existing Building Code® (IEBC®), and codes that govern the installation of mechanical, plumbing, fuel gas service, and other aspects of building construction. FEMA has deemed that the latest published editions of the I-Codes meet or exceed NFIP requirements for buildings and structures in flood hazard areas. Excerpts of the flood provisions of the I-Codes are available on FEMA’s Building Code Resource webpage (<https://www.fema.gov/building-code-resources>).

3.1 International Residential Code

The IRC applies to one- and two-family dwellings and townhomes not more than three stories above grade plane. The IRC requirements related to flood openings, summarized in Table 1, are similar to but generally exceed NFIP requirements.

Table 1 refers to selected requirements of the 2018 IRC and notes changes from the 2015 and 2012 editions; subsequent editions of the IRC should include comparable requirements.

IRC COMMENTARY

The ICC publishes companion commentary for the IRC. Although not regulatory, the commentary provides guidance that is useful in complying with, interpreting, and enforcing the requirements of the code.

Table 1: Comparison of Selected 2018 IRC and NFIP Flood Opening Requirements

Topic	Summary of Selected 2018 IRC Requirements and Changes from 2015 and 2012 Editions	Comparison with NFIP Requirements
Flood openings	<p>Section R322.2.2(2) Enclosed area below design flood elevation. Requires enclosed areas below the design flood elevation, including crawlspaces, to have flood openings (non-engineered or engineered) that meet listed criteria and that are installed in accordance with R322.2.2.1. The enclosed area is measured on the exterior of the enclosure. The listed criteria are equivalent to non-engineered and engineered openings, with the addition of a minimum size (not less than 3 inches in any direction in the plane of the wall). <u>Change from 2015 to 2018 IRC:</u> No change. <u>Change from 2012 to 2015 IRC:</u> No change.</p>	Equivalent to NFIP 44 CFR § 60.3(c)(5) but with more specificity: measurement of enclosed area and minimum dimensions of opening.
Installation of flood openings	<p>Section R322.2.2.1 Installation of openings. Specifies the following for the installation of flood openings:</p> <ul style="list-style-type: none"> • At least two openings on different sides of an enclosure are required, and if more than one enclosed area is present, each must have openings on exterior walls. • The bottom of each opening must be not more than 1 foot above the higher of the final interior grade (or floor) and the finished exterior grade immediately under each opening. • Openings are permitted to be installed in doors and windows. <p><u>Change from 2015 to 2018 IRC:</u> No change. <u>Change from 2012 to 2015 IRC:</u> Installation requirements moved to new section.</p>	More specificity than NFIP 44 CFR § 60.3(c)(5): openings on different sides, openings installed above higher of interior and exterior grade or floor, and openings installed in doors.
Breakaway walls	<p>Section R322.3.5 Walls below design flood elevation. Requires walls below elevated dwellings in Coastal High Hazard Areas (Zone V) and Coastal A Zones that are intended to break away under flood loads to have flood openings that meet the requirements of Section R322.2.2(2). <u>Change from 2015 to 2018 IRC:</u> Section number was R322.3.4. <u>Change from 2012 to 2015 IRC:</u> New requirement in Coastal High Hazard Areas (Zone V) and Coastal A Zones if delineated.</p>	Exceeds NFIP 44 CFR § 60.3(e)(5): openings in breakaway walls and Zone V requirements applied in Coastal A Zones if delineated.

3.2 International Building Code and ASCE 24

The flood provisions of the latest published editions of the IBC meet or exceed NFIP requirements for buildings, largely through reference to the standard ASCE 24, *Flood Resistant Design and Construction*, developed by the American Society of Civil Engineers (ASCE). The IBC applies to all applicable buildings and structures. While primarily used for buildings and structures other than dwellings within the scope of the IRC, the IBC may be used to design dwellings. ASCE 24 requirements for flood openings, summarized in Table 2, are similar to but generally exceed and are more specific than NFIP requirements. Table 2 refers to selected requirements of the 2018 IBC and ASCE 24-14 (noting changes from 2015 and 2012 IBC and ASCE 24-05); subsequent editions of the IBC and ASCE 24 should include comparable requirements.

IBC AND ASCE 24 COMMENTARIES

The ICC publishes companion commentary for the IBC, and ASCE publishes companion commentary for ASCE 24. Although not regulatory, the commentaries provide guidance that is useful in complying with, interpreting, and enforcing the requirements.

Table 2: Comparison of Selected 2018 IBC and ASCE 24-14 Flood Opening Requirements with NFIP Requirements

Topic	Summary of Selected 2018 IBC/ASCE 24-14 Requirements and Changes from 2015 and 2012 IBC/ASCE 24-05	Comparison with NFIP Requirements
Certification of engineered openings	<p>Section 1612.4(1.2). Requires submission of a certification statement that the design provides for equalization of hydrostatic flood forces in accordance with ASCE 24, Section 2.7.2.2 (for engineered openings), if flood openings do not meet the requirements of ASCE 24, Section 2.7.2.1 (for non-engineered openings). <u>Change from 2015 to 2018 IBC:</u> Section number was 1612.5. <u>Change from 2012 to 2015 IBC:</u> No change.</p>	Equivalent to NFIP 44 CFR § 60.3(c)(5).
Breakaway walls	<p>ASCE 24 Section 2.7.1.1. Requires openings in breakaway walls. <u>Change from ASCE 24-05:</u> New requirement for openings in breakaway walls in Coastal High Hazard Areas and Coastal A Zones.</p>	Exceeds NFIP 44 CFR § 60.3(e)(5) by requiring openings in breakaway walls.
Non-engineered openings	<p>ASCE 24 Section 2.7.2.1. Specifies non-engineered openings, requires enclosed areas to be measured on the exterior, specifies minimum size (not less than 3 inches in any direction in the plane of the wall), and requires that the presence of louvers, blades, screens, faceplates or other covers, and devices be accounted for in determining net open area. <u>Change from ASCE 24-05:</u> Specifies measurement of enclosed areas to determine square footage. Clarifies that the presence of louvers, blades, screens, faceplates, and devices must be accounted for in the measurement of net open area of flood openings.</p>	Equivalent to NFIP 44 CFR § 60.3(c)(5) but with more specificity: measurement of enclosure area, minimum dimension of openings, and measurement of net open area.
Engineered openings	<p>ASCE 24 Section 2.7.2.2. Specifies engineered openings with emphasis on performance accounting for the presence of louvers, blades, screens, grilles, faceplates or other covers, and devices and ensuring that the difference between exterior and interior flood levels does not exceed 1 foot, with guidance related to the rate of rise and fall in excess of (or less than) 5 feet per hour. Specifies minimum size (not less than 3 inches in any direction in the plane of the wall). Provides the formula for calculating the total net area of required engineered openings. <u>Change from ASCE 24-05:</u> Greater emphasis on performance and the effects of louvers, blades, screens, grilles, faceplates, and devices and revises the table of coefficients of discharge</p>	Equivalent to NFIP 44 CFR § 60.3(c)(5) but with more specificity: minimum rate of rise and fall, minimum dimension of openings, and formula for engineered openings.
Installation of flood openings	<p>ASCE 24 Section 2.7.3. Specifies the following for the installation of openings:</p> <ul style="list-style-type: none"> • At least two openings in at least two walls of each enclosed area • The bottom of each opening not more than 1 foot above the higher of the final interior grade or floor and the finished exterior grade immediately under each opening • Openings in doors and windows permitted <p><u>Change from ASCE 24-05:</u> Consolidates installation requirements, which apply to both non-engineered and engineered openings, and clarifies that the position is relative to the higher of the interior and exterior grade or floor.</p>	Equivalent to NFIP 44 CFR § 60.3(c)(5) but with more specificity: openings on different sides, bottom of openings above higher of interior and exterior grade or flood, and openings in doors and windows.

4 NFIP Flood Insurance Implications

Careful attention to compliance with NFIP requirements for enclosures below elevated lowest floors and flood openings is important during the design, plan review, construction, and inspection of buildings in SFHAs. Compliance influences vulnerability to flood damage and also the cost of NFIP flood insurance policies. The presence of enclosures may result in higher NFIP flood insurance premiums. If flood openings are not compliant, the floor of a crawlspace or the floor of an enclosure will be deemed the lowest floor for insurance rating purposes, which may result in higher NFIP flood insurance premiums, especially if the floor of the crawlspace or enclosure is more than 1 foot below the BFE.

5 Documenting Building Elevations and Flood Openings Using the NFIP Elevation Certificate

Communities are required to obtain the following from permit holders for buildings in SFHAs: the surveyed elevation of lowest floors of new buildings and buildings that have been Substantially Improved or repaired after incurring Substantial Damage. The elevations may be provided on the NFIP Elevation Certificate or in other formats.

The NFIP Elevation Certificate is designed to facilitate the collection of information that will help local officials evaluate compliance with floodplain management requirements and to provide the information necessary for the proper rating of NFIP flood insurance policies. For guidance on completing the certificate, see *NFIP Elevation Certificate and Instructions* (FEMA, 2015) and FEMA 467-1, *Floodplain Management Bulletin: Elevation Certificate* (FEMA, 2004).

The required information includes the following characteristics of crawlspaces, enclosures, and attached garages:

- Square footage of the enclosed area, measured on the outside of the enclosure walls
- Number of permanent flood openings within 1.0 foot above adjacent grade
- Total net open area of flood openings
- Whether engineered openings are used

According to the NFIP Elevation Certificate instructions, when an enclosed area has no flood openings or if all flood openings (non-engineered

NFIP ELEVATION CERTIFICATE COMMENTS

The comment section of the NFIP Elevation Certificate should be used to note characteristics of enclosures and flood openings that comply with the requirements but that, without close inspection, may appear to be non-compliant. In particular, without clarifying comments on engineered openings, local officials and insurance agents may inadvertently determine that enclosures are non-compliant and deem the floor of the enclosure the lowest floor, resulting in unnecessarily high NFIP flood insurance premiums.

or engineered) are higher than 1.0 foot above the adjacent grade, “N/A” (not applicable) should be entered for both the number of flood openings within 1.0 foot above adjacent grade and total net open area of flood openings. If the bottoms of some flood openings are within 1.0 foot above the adjacent grade, only the number and net open area of those openings should be recorded (openings that are higher than 1.0 foot are not included).

The certificate does not require users to determine whether any portion of a flood opening is above the BFE. However, for compliance purposes, see Section 8.3.6 of this Technical Bulletin for guidance on flood openings that extend above the BFE, which can occur in areas with shallow flooding. In these areas, even if the bottom of an opening is less than 1.0 foot above grade, a portion of the opening may extend above the BFE.

The NFIP Elevation Certificate has space for comments. Comments must be entered when engineered openings are used. Section 9.3.2 of this Technical Bulletin describes the documentation that is required for engineered openings and that must be attached to the certificate.

6 Use of Enclosed Areas Below Elevated Buildings

The NFIP regulations specify that enclosed areas under elevated buildings in SFHAs may be allowed if the enclosed areas are used solely for:

- Parking of vehicles (attached garages or parking areas below elevated buildings)
- Building access (stairwells, foyers)
- Storage (recommended to be limited to storage of low-value items)

The NFIP regulations do not list crawlspaces and under-floor spaces as allowable uses of enclosed areas. However, buildings in Zone A may be elevated using perimeter foundation walls that create these enclosed areas. Crawlspaces and under-floor spaces provide access to under-floor utilities such as pipes, ductwork, and electric conduits.

DRY FLOODPROOFED BUILDINGS

The only buildings with enclosed areas that are not required to have flood openings are non-residential buildings that are engineered to be dry floodproofed. For information on dry floodproofing, see FEMA P-936, *Floodproofing Non-Residential Buildings* (FEMA, 2013), and NFIP Technical Bulletin 3, *Non-Residential Floodproofing – Requirements and Certification*. FEMA has granted exceptions to a small number of communities to allow engineered, dry-floodproofed basements in specific circumstances.

A compliant enclosed area below the BFE can be rendered non-compliant by installing features that are inconsistent with the limitations on uses. Examples of features that are not allowed below the BFE are:

- Appliances
- Heating and air conditioning equipment
- Ventilation
- Ductwork
- Plumbing fixtures
- Materials that are not flood damage-resistant materials
- More than the minimum electric service required to address life-safety and electric code requirements for vehicle parking, building access, or storage

NON-CONVERSION AGREEMENTS

When some communities issue permits for buildings with enclosed areas below the BFE, permittees are required to execute Non-Conversion Agreements. These agreements document the permittees' understanding that the allowed use of enclosures is limited, that conversion to other uses is not allowed, and that modifying enclosed areas may render a building non-compliant with minimum requirements and result in higher NFIP flood insurance rates.

7 Foundation Walls and Enclosure Walls that Require Flood Openings

The NFIP regulations require that enclosed areas below the lowest floors of elevated buildings in Zone A have flood openings to equalize the hydrostatic flood forces (loads) on the enclosure walls. This requirement applies whether the walls are crawlspace, load-bearing, or non-load-bearing walls.

Examples of foundation and enclosure walls that require openings are listed below and described in Sections 7.1 through 7.9.

- Solid perimeter foundation walls (crawlspaces and under-floor spaces)
- Solid perimeter foundation walls (below-grade crawlspaces)
- Garages attached to elevated buildings
- Enclosed areas under buildings elevated on open foundations
- Enclosed areas with breakaway walls under buildings elevated on open foundations
- Above-grade (elevated) enclosed areas
- Two-level enclosed areas
- Solid perimeter foundation walls on which manufactured homes are installed
- Accessory structures (detached garages and storage sheds)

7.1 Solid Perimeter Foundation Walls (Crawlspaces and Under-Floor Spaces)

The crawlspace or under-floor space that is created when a building is elevated on a solid perimeter foundation wall that is below the BFE (see Figure 2) must meet all of the requirements for enclosed areas, including flood openings. If brick veneer, siding, or other material covers the wall, the openings in the wall must penetrate into the enclosed area. A crawlspace access door does not qualify as a flood opening unless the door has an opening installed in it or otherwise meets the performance requirement to allow automatic entry and exit of floodwater.

Section 8.2 of this Technical Bulletin explains that the bottom of each opening must be no higher than 1 foot above the higher of the finished interior grade (or floor) or the finished exterior grade immediately under the opening. Therefore, the expected finished exterior grade and the final interior grade (or floor) of a crawlspace must be known before the location of the openings in a perimeter foundation wall can be determined.

Building codes may require ventilation of under-floor spaces. Ventilation openings are typically positioned near the top of the foundation wall to facilitate air flow. In most cases, ventilation openings are too far above grade to satisfy flood opening requirements.

In SFHAs where BFEs are several feet above grade or when owners want enough head room in an under-floor space to allow for parking of vehicles and storage, solid perimeter foundation walls may be used to create a full-height, under-floor space (see Figure 3). The walls surrounding an under-floor space must meet all flood-opening requirements.

**CONDITIONED CRAWLSPACES
MUST HAVE FLOOD OPENINGS**

In many parts of the country, a common practice is to build “conditioned crawlspaces” that are sealed and have mechanical ventilation. In SFHAs, all crawlspaces must have flood openings that meet the NFIP requirements and building codes.



Figure 3: Full-height, solid perimeter walls surrounding a garage and storage area with flood openings (only three openings are shown)

Full-height, under-floor spaces must also meet all other NFIP requirements, which will minimize the likelihood of future conversion to uses other than the allowed uses (parking of vehicles, building access, or storage). Features that are inconsistent with the allowed uses are not permitted (see Section 6).

A backfilled stem wall foundation (also called chain wall, raised-slab-on-grade, and slab-on-stem-wall-with-fill) can look like a solid perimeter foundation wall from the outside, but a backfilled stem wall foundation is backfilled with compacted structural fill, concrete, or gravel that supports the floor slab (see Figure 4). Because stem wall foundations are backfilled, flood openings are not required and should not be installed.

BACKFILLED STEM WALLS AND NFIP ELEVATION CERTIFICATES

When the NFIP Elevation Certificate for a building elevated on a backfilled stem wall is completed, the foundation should be described in the comment section to clarify that the foundation is not a crawlspace and therefore does not require and should not have flood openings.

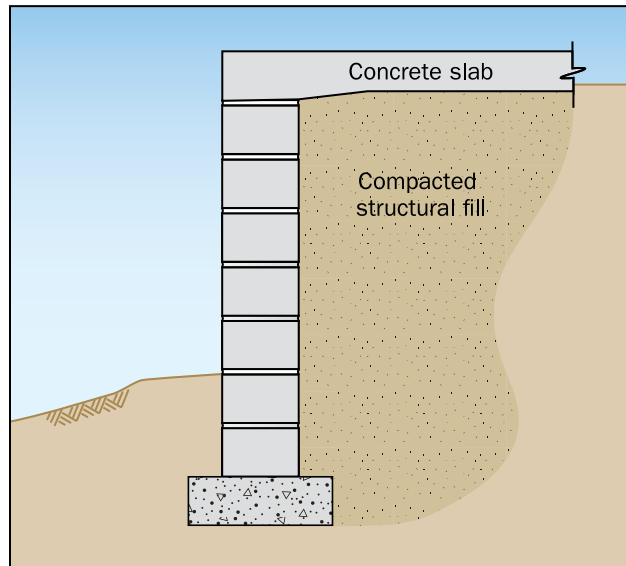

Figure 4: Backfilled stem wall foundation; flood openings not required

7.2 Solid Perimeter Foundation Walls (Below-Grade Crawlspaces)

The NFIP regulations do not allow buildings in SFHAs to have basements (areas below grade on all sides) except for engineered, non-residential buildings in Zone A that are designed and certified to be dry floodproofed. Therefore, crawlspaces that are below grade on all sides are not allowed because they are basements. An exception is available **only in SFHAs with shallow flooding** and then only if specific requirements and limitations are met. For more information,

LIMITATIONS ON BELOW-GRADE CRAWLSPACES

Before authorizing below-grade crawlspaces, communities are required to adopt specific provisions in their ordinances to be consistent with the limitations specified in NFIP Technical Bulletin 11. Communities should consult NFIP State Coordinators or FEMA Regional Offices for the appropriate language.

see NFIP Technical Bulletin 11, *Crawlspace Construction for Buildings Located in Special Flood Hazard Areas: National Flood Insurance Program Interim Guidance*.

According to Technical Bulletin 11, below-grade crawlspaces may be allowed if the foundation wall height is less than 4 feet from the bottom of the floor joist/truss to the top of the footing or interior grade/floor (whichever is higher). The top of the footing or interior grade/floor must be no more than 2 feet below grade (see Figure 5). Flood openings are required in the foundation walls surrounding below-grade crawlspaces and, as noted in Section 7.1, ventilation may be required. Because below-grade crawlspaces may contribute to increased humidity and mold growth, Technical Bulletin 11 requires that below-grade crawlspaces have adequate drainage systems to minimize moisture damage.

Although crawlspaces that meet the limitations in Technical Bulletin 11 are not considered basements for floodplain management purposes, they are considered basements for NFIP flood insurance purposes, and premiums will be higher if the grade inside a crawlspace is below the exterior grade on all sides.

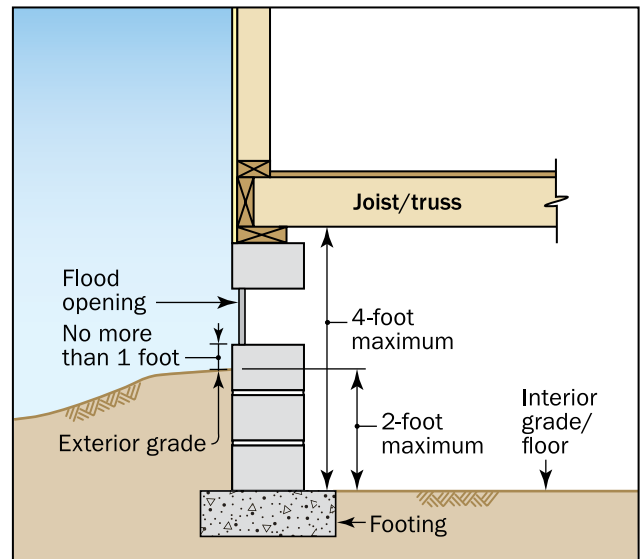

Figure 5: Limitations on below-grade crawlspaces in shallow flood hazard areas (see NFIP Technical Bulletin 11 for more information)

7.3 Garages Attached to Elevated Buildings

Many buildings, especially homes, have an attached garage that extends laterally from the building and may or may not have living space above it. The floor of a garage that is attached to a building in an SFHA is allowed to be below the BFE if the garage meets all of the requirements for an enclosed area below the BFE. The use of the garage space must be limited to parking of vehicles, building access, or storage.

Flood openings are required in the exterior walls of garages in Zone A. Openings may be installed in garage doors (see Figure 6). However, because garage doors are likely to be replaced over the life of a building and subsequent owners may inadvertently replace garage doors without openings, flood openings should be installed in garage doors only when there is insufficient wall area in which to install the required number of openings.

Garage doors themselves do not meet the requirements for openings because human intervention would be needed to open garage doors when flooding is expected. Human intervention is inconsistent with the requirement that openings allow for the automatic entry and exit of floodwater. Garage doors with mechanisms that open the doors when water is detected do not meet the requirements because electric service cannot be guaranteed even if a backup power source is provided. Similarly, gaps that may be present between the garage door and the door jamb or walls do not guarantee automatic entry and exit of floodwater and do not count toward the net open area requirement.



Figure 6: Engineered openings in garage doors

7.4 Enclosed Areas Under Buildings Elevated on Open Foundations

A building that is elevated on an open foundation (e.g., piers, posts, columns, pilings) in Zone A may have enclosed areas below the elevated floor (see Figure 7). Sometimes, only part of the footprint is enclosed, such as for a stairwell or storage room. All of the requirements for enclosed areas apply. Requirements include openings, elevated utilities, flood damage-resistant materials, and limitations on use (parking of vehicles, building access, or storage).

Skirting used to enclose areas under manufactured homes or other elevated buildings is typically made of weather-resistant material and extends from the bottom of the floor system down to grade. Rigid vinyl and aluminum skirting must have flood openings. Flood openings are not required when flexible skirting is used, but flexible skirting may be pushed against foundations if floodwater rises rapidly, in which case open lattice may be more appropriate. Unattached skirting can become dislodged during flooding and generate damaging debris.

NATIONAL FIRE PROTECTION ASSOCIATION (NFPA) INSTALLATION STANDARD AND SKIRTING

NFPA 225, *Model Manufactured Home Installation Standard* (NFPA, 2017), specifies that the installation of skirting does not trigger the requirement for flood openings if the skirting does not provide structural support and would collapse under wind and water loads that are less than those expected during the base flood event without causing structural damage to the elevated home or foundation.

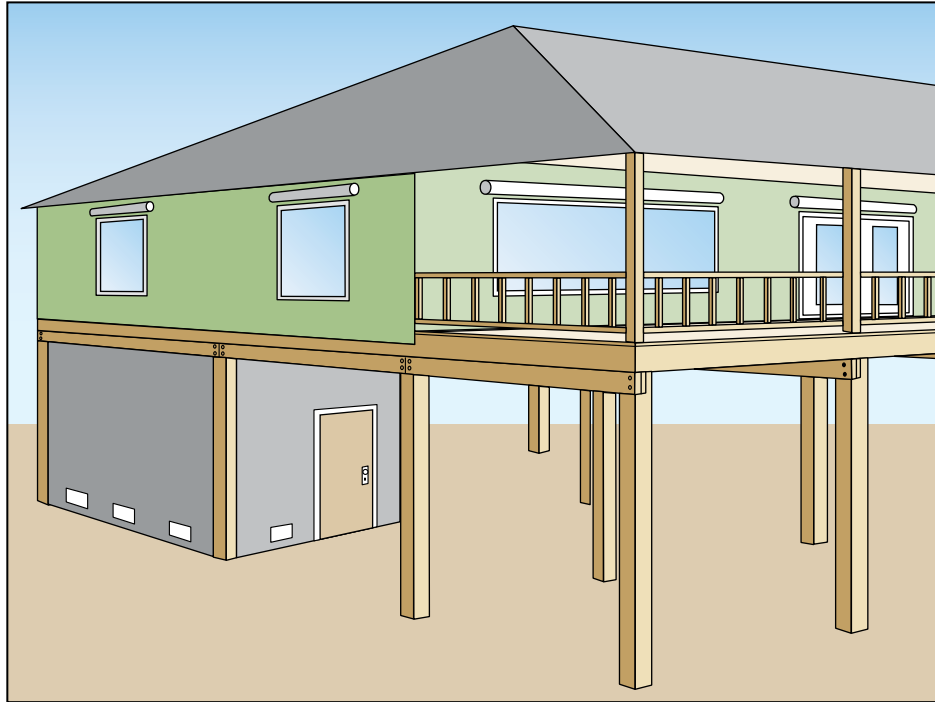

Figure 7: Enclosure with flood openings under a house elevated on pilings

UTILITY CHASES

For floodplain management and NFIP flood insurance purposes, utility chases designed to protect utility lines from freezing are not considered enclosures. Utility chases must be small and not allow access for a person to enter the space (access panels for servicing the lines are appropriate).

Because a utility chase is not considered an enclosure, it does not have to have flood openings (but flood openings may be provided). The utility chase must be constructed of flood damage-resistant materials below the BFE, and the enclosed utility lines must meet the requirement to be watertight and capable of withstanding flood loads (hydrostatic, hydrodynamic, wave).

7.5 Enclosed Areas with Breakaway Walls Under Buildings Elevated on Open Foundations

Open foundations (e.g., piers, posts, columns, pilings) are recommended in riverine SFHAs where flow velocities are expected to exceed 10 feet per second and in coastal areas where breaking wave heights during base flood conditions are expected to be between 1.5 and 3 feet (called Coastal A Zones). Buildings in these areas may be exposed to significant hydrodynamic loads, debris impact, and scour, any of which could be sufficient to damage typical perimeter foundation walls and enclosure walls even when there are flood openings.

Many Flood Insurance Rate Maps (FIRMs) for coastal communities that have been revised since 2009 show a Limit of Moderate Wave Action (LiMWA), which delineates the inland extent of the 1.5-foot wave. In Coastal A Zones, identified as Zone A on FIRMs, FEMA recommends that walls surrounding enclosed areas be designed as breakaway walls. To comply with the NFIP requirements, flood openings are required in breakaway walls in Zone A.

The NFIP regulations require that enclosures below elevated buildings in SFHAs identified as Zone V meet the same requirements for enclosures in Zone A, except that (1) walls must be non-supporting breakaway walls, open lattice-work, or insect screening and (2) flood openings are not required (see NFIP Technical Bulletin 9, *Design and Construction Guidance for Breakaway Walls*). The guidance in Technical Bulletin 9 should be used when flood openings are installed in breakaway walls to minimize wall failure under flooding that occurs more frequently than the base flood.

I-CODES AND COASTAL A ZONE

Starting with the 2015 editions, I-Codes treat Coastal A Zones like Zone V if the LiMWA is delineated on FIRMs or if communities designate Coastal A Zones. In addition, the I-Codes and ASCE 24-14 require flood openings in all breakaway walls, including those in Coastal A Zones and Zone V.

Post-flood assessments indicate that breakaway walls with openings prevent wall failure under frequent, shallow flood events. Preventing frequent wall failures reduces debris, keeps enclosure interiors and contents protected from wind-driven rain and sand, and reduces the cost of replacing walls.

7.6 Above-Grade (Elevated) Enclosed Areas

In flood hazard areas that experience frequent flooding, some owners construct enclosures with floor systems that are elevated above grade, not in contact with the ground, but still below the BFE (see Figure 8). Placing the enclosure floor above grade minimizes the potential for damage to the enclosure and contents during frequent, low-level flood events.

Above-grade enclosures must meet all requirements applicable to enclosures (flood openings, flood damage-resistant materials, and used only for storage or building access). The floor system of above-grade enclosures may be independently supported on piers or posts, or enclosures may be structurally attached to the building's column or piling foundation. Although the floors of above-grade enclosures are not the lowest floor for floodplain management purposes, the enclosure floors are the lowest floor for NFIP flood insurance rating purposes.

One or more floor grates should be installed in the enclosure floor to reduce the potential for structural damage. Damage could result from buoyancy loads on the enclosure floors before water enters through the flood openings installed in walls. Openings in floors also allow enclosures to drain completely, reducing the potential for damage caused by the added weight of water.

“HANGING ENCLOSURE”

The term “hanging enclosure” has been used to refer to raised, above-grade enclosures although above-grade enclosures are typically supported by other means and do not actually hang from elevated buildings.

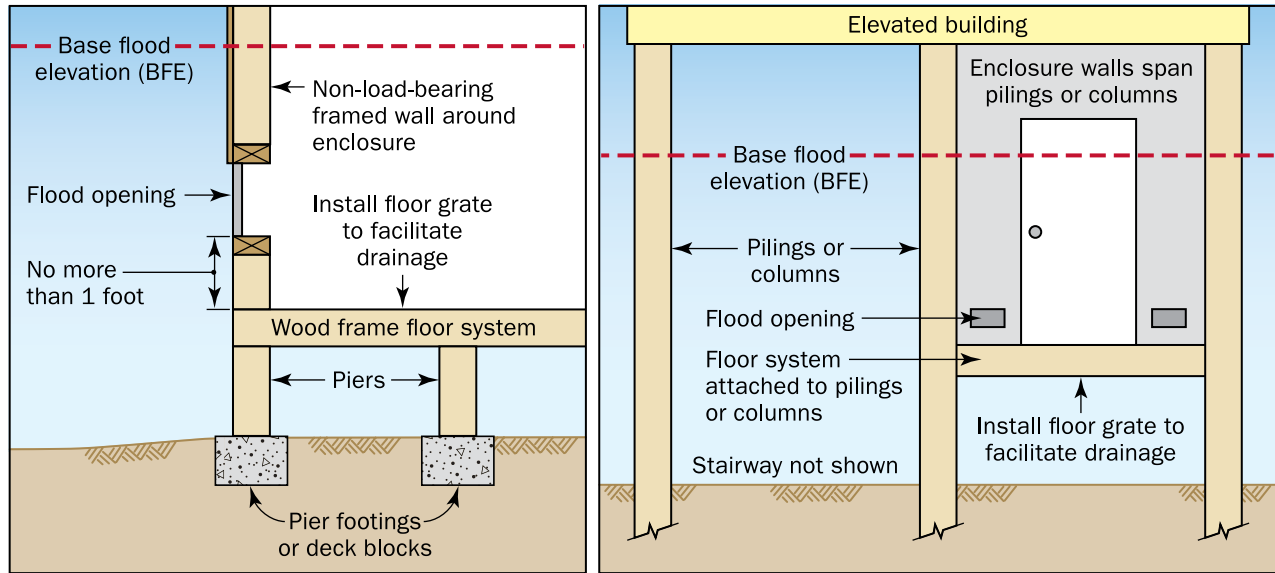

Enclosure floor on piers under house supported on pilings or columns (pilings/columns not shown)

Enclosure floor attached to pilings or column

Figure 8: Above-grade enclosures

ABOVE-GRADE ENCLOSURES AND NFIP FLOOD INSURANCE

NFIP flood insurance policies for elevated buildings with above-grade enclosures are rated assuming the above-grade enclosure is the lowest floor (i.e., the floor of the enclosure instead of the floor of the elevated building). See the “Lowest Floor Guide” section of the *NFIP Flood Insurance Manual* (FEMA, 2019). Above-grade enclosures can result in higher NFIP flood insurance premiums than enclosures with floors that are at-grade or close to grade. Owners should ask their insurance companies to submit requests to the NFIP for a special rating for buildings with above-grade enclosures.

7.7 Two-Level Enclosed Areas

In flood hazard areas where the BFE is more than one story above the ground, some owners want to build two-level enclosures (see Figure 9). For compliance purposes, to avoid the second-level enclosure from being identified as the lowest floor, both enclosure levels must meet all of the requirements for enclosed areas, including openings, elevated utilities, flood damage-resistant materials, and limitations on use (parking of vehicles, building access, or storage). To facilitate drainage from the upper level of the enclosure, an opening with a grate should be installed in the floor.

TERMS USED FOR TWO-LEVEL ENCLOSURES

Two-level enclosures are also referred to as two-story enclosures, double enclosures, and stacked enclosures.

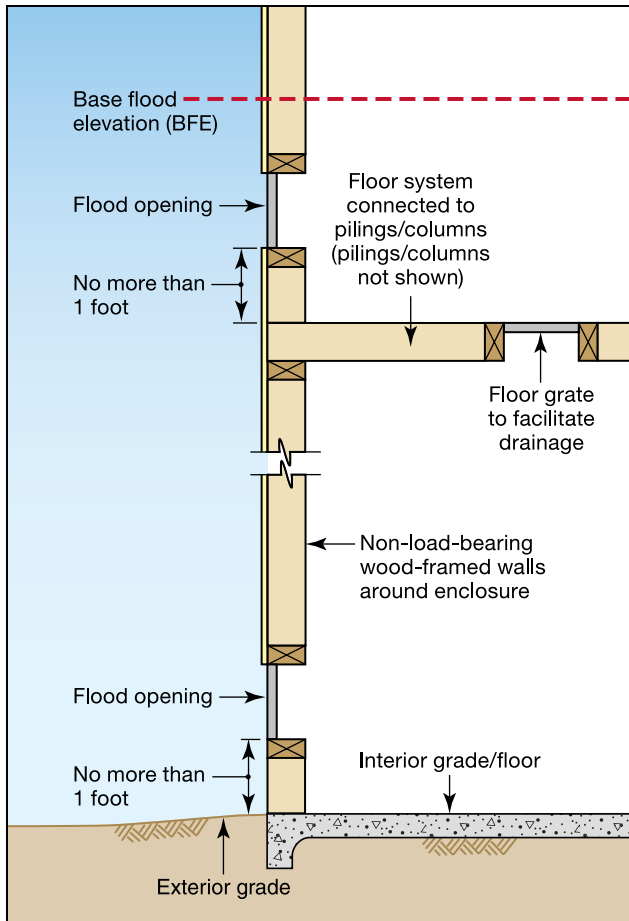

Figure 9: Two-level enclosure with non-load-bearing walls under building elevated on pilings or columns; configuration also applies if walls are load-bearing

Figure 9 shows a two-level enclosure in which the surrounding walls are not load-bearing; the same configuration and requirement apply if the surrounding walls are load-bearing perimeter walls.

Two-level enclosures are unusual and warrant consideration of flood loads based on site-specific flood conditions. Local officials may require that buildings with two-level enclosures be designed and certified by a registered design professional rather than rely on non-engineered foundations and enclosure configurations.

TWO-LEVEL ENCLOSURES AND NFIP FLOOD INSURANCE

Designers and owners should be aware that a building with a two-level enclosure, even if allowed by permit, will have a higher NFIP flood insurance premium than if the building has a one-level enclosure. Even if a two-level enclosure complies with building codes and floodplain management requirements for enclosures, the upper floor of the two-level enclosure will be deemed the lowest floor for insurance rating purposes (the lowest floor for flood insurance purposes is the first floor elevated above ground). Owners should ask their insurance companies to submit requests to the NFIP for a special rating for buildings with two-level enclosures.

7.8 Solid Perimeter Foundation Walls on which Manufactured Homes Are Installed

Manufactured homes may be installed on solid perimeter foundation walls that enclose the space below the homes (see Figure 10). Even if not part of a home's load-bearing support system, a solid perimeter foundation wall is required to have openings; otherwise, hydrostatic loads may damage the wall, which could lead to damage of the home's supporting foundation and anchor system.

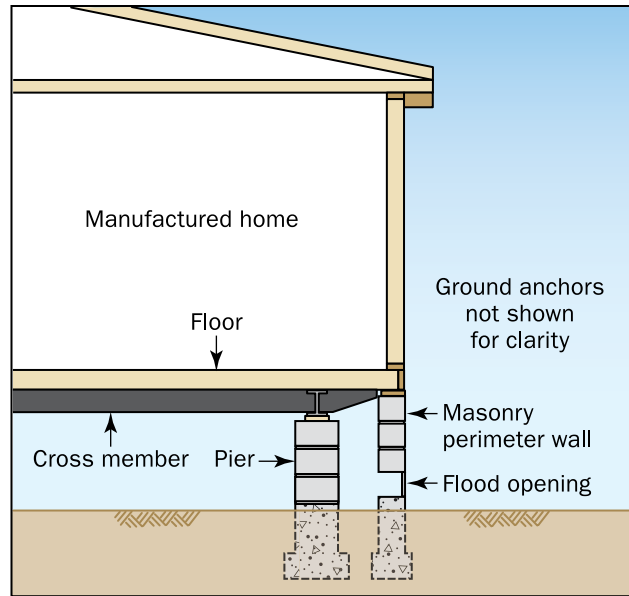

Figure 10: Manufactured home supported on interior piers and masonry perimeter wall with flood openings (ground anchors not shown)

7.9 Accessory Structures

Communities participating in the NFIP are required to regulate all development in SFHAs, including detached garages, detached storage buildings, and small storage sheds. Accessory structures may be elevated in accordance with the requirements for elevated buildings or dry floodproofed.

When communities have FEMA-approved limitations on the size of accessory structures or when communities grant variances for non-elevated accessory structures, the structures may be allowed without elevation provided the structures are wet floodproofed (see NFIP Technical Bulletin 7, *Wet Floodproofing Requirements for Certain Buildings Located in Special Flood Hazard Areas*). Alternatively, communities without FEMA-approved size limits may consider granting variances for non-elevated accessory structures in accordance with FEMA policies and guidance.

ADDITIONAL ACCESSORY STRUCTURE CONSIDERATIONS

Some communities have FEMA-approved regulations that specify limitations on the size of accessory structures that are allowed in SFHAs without having to comply with elevation requirements. Other considerations for accessory structures are set forth in FEMA policies and guidance.

Local officials should consult NFIP State Coordinators or FEMA Regional Offices for additional guidance and for appropriate size limits and language to include in local regulations.

Wet-floodproofed accessory structures must comply with the following measures:

- Use is limited to parking of vehicles and storage
- Utilities are elevated
- Materials below the BFE are flood damage-resistant materials
- Flood opening requirements are satisfied
- Structures are anchored to resist flotation, collapse, or lateral movement under flood conditions

A best practice is to require Non-Conversion Agreements when non-elevated accessory structures are allowed. These agreements, when recorded with property deeds, inform future owners about the limitations and the wet-floodproofing measures. Accessory structures that are allowed to be wet floodproofed must not be used for any habitable or other prohibited purpose.

8 Requirements and Guidance for Installation of Flood Openings

The NFIP regulations specify installation requirements for all flood openings, whether non-engineered or engineered. See Section 9 of this Technical Bulletin for information on non-engineered and engineered flood openings. Installation requirements specify the minimum number of openings and the maximum height of openings above grade. The requirements and guidance on installation are provided in Sections 8.1 through 8.3.

8.1 Location and Minimum Number of Flood Openings

Every enclosed area is required to have at least two flood openings on exterior walls. Flood openings should be installed in at least two sides of each enclosed area to decrease the chance that all openings will be blocked by floating debris and to allow for more even filling and drainage of enclosed areas than if openings are installed on only one side. FEMA recommends that openings be distributed around the perimeter of enclosed areas unless there is clear justification for putting all of the openings on only one or two sides, such as in townhouses with limited exterior walls (see Section 8.3.4) and buildings set into sloping sites (see Section 8.3.2). If openings are not distributed around the perimeter, an imbalance in flood loads could result in damage to or collapse of walls.

LOCATION OF FLOOD OPENINGS

The IRC and IBC (by reference to ASCE 24) require flood openings “on different sides of each enclosed area” (IRC R322.2.2.1) and “in at least two walls of each enclosed area” (ASCE 24, Section 2.7.3).

Figure 11 shows a foundation plan with multiple enclosures and openings in the perimeter wall of each enclosed area. Note that the number of openings shown is for illustration purposes only; the total number of openings and the adequacy of the net open area of the openings depend on the type of opening and whether air-vent devices or engineered openings are installed.

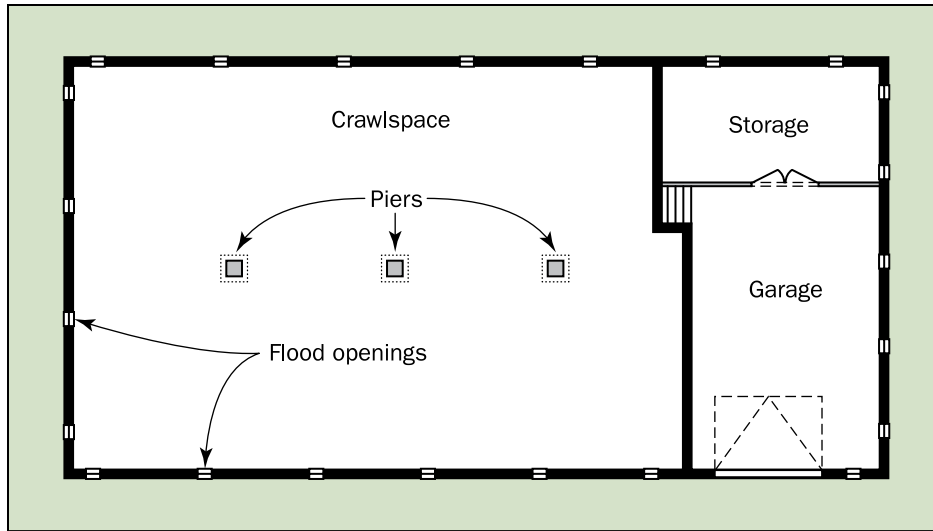

Figure 11: Foundation plan of home with multiple enclosed areas, each with flood openings (number of openings for illustration purposes only)

In some situations, openings in interior walls or partitions are necessary to ensure that floodwater can reach all enclosed areas and minimize unbalanced hydrostatic loads on interior and exterior walls. When openings are used in interior walls, the total number of openings and their net open area should be based on the size of the enclosed area, but openings in interior walls are not counted toward the required total opening requirement based on the exterior measurement of the enclosed area. To maintain safe fire separation, flood openings should not be placed in the wall separating a garage from living spaces and crawlspaces unless devices used as flood openings that are designed to satisfy fire-separation requirements are used.

8.2 Height of Flood Openings Above Grade or Floor

The bottom of each flood opening must be positioned no higher than 1 foot above the higher of the final (finished) interior or exterior grade or the floor that is immediately under each opening so water will begin to flow through the opening when water rises just above the bottom of the opening. The purpose of this requirement is to satisfy the performance expectation that the difference in water levels between the interior and exterior will not exceed 1 foot as floodwater begins to rise and as it recedes from the site. To reduce the amount of water trapped inside, a good practice is to install some openings closer to grade than the maximum 1 foot allowed. See Section 8.3.6 for information on openings that extend above the BFE in areas with shallow flooding.

When interior and exterior grades are different, the higher of (1) the finished exterior grade immediately under each opening and (2) the final interior grade or floor is used to determine

ENCLOSURES BELOW GRADE ON ALL SIDES ARE BASEMENTS

An enclosure that is below grade on all sides is a basement regardless of whether the interior grade or floor is below grade because backfill, topsoil, or landscaping materials were added or because the footing trenches inside the perimeter foundation walls are not completely backfilled. Basements do not comply with the minimum NFIP requirements. In addition, the presence of such below-grade enclosures will result in higher NFIP flood insurance premiums.

the position of flood openings. The following should be considered when determining which grade or floor to use:

- **Finished exterior grade.** Care should be taken when placing backfill, topsoil, or landscaping materials around the outside of enclosures, especially solid perimeter foundation walls. If the finished exterior grade is higher than the interior grade on all sides of the building, the enclosed area will be a basement as defined by the NFIP.
- **Final interior grade or floor.** The trench that is excavated to construct footings and foundation walls must be backfilled completely; otherwise, a basement will be created. If the interior grade or floor is higher than the exterior grade, the openings must be no higher than 1 foot above the interior grade or floor.

8.3 Examples of Flood Opening Installations

The following examples of flood opening installations are described in Sections 8.3.1 through 8.3.6:

- Interior grade or floor higher than the exterior grade
- Sloping sites
- Buildings with large enclosed areas
- Townhouses with limited exterior walls
- Buildings with multiple enclosures
- Openings in areas with shallow flooding

8.3.1 Interior Grade or Floor Higher than the Exterior Grade

This section describes enclosures in which the interior grade or floor is higher than the exterior grade. As water rises against the outside of the foundation, the interior fill or slab resists the hydrostatic load. When water rises above the interior grade or slab, the lateral load will become unbalanced and therefore must be equalized with openings that allow water to automatically enter and exit.

Figure 12 is an example of a framed enclosure below a manufactured home that is elevated on columns. As indicated by the driveway on the left, the interior slab is higher than the exterior grade along the side of the building. The flood openings are within 1 foot of the interior floor surface. Here, the full-height enclosed area is used for parking of vehicles and storage.

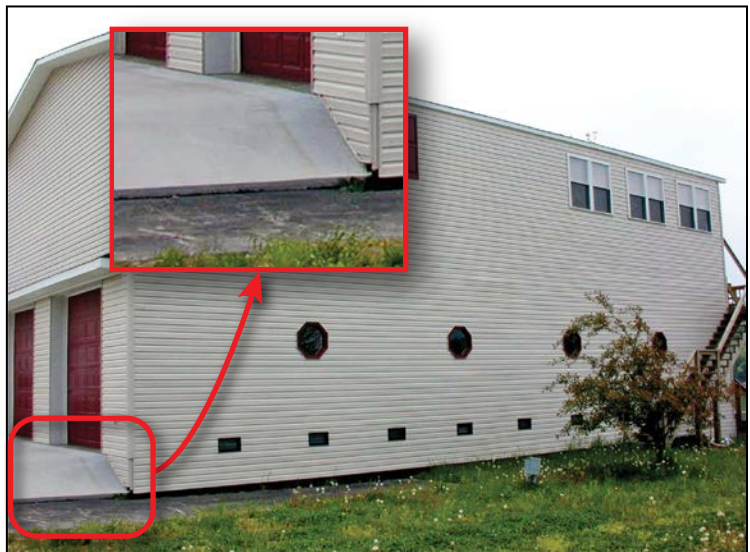

Figure 12: Manufactured home installed on columns above a full-height, framed garage (note elevation of thick driveway slab on left; the flood openings are within 1 foot of interior floor surface)

When viewed from the outside, an enclosure with the interior grade or floor higher than the exterior grade may appear non-compliant with the installation requirements for openings because the openings appear to be too high above the exterior grade. Therefore, the final documentation of as-built elevations should note the difference in interior and exterior grades. For example, if the NFIP Elevation Certificate is used, the comments should indicate whether the openings are (or are not) within 1 foot of the higher of the two grades and should explain that the interior grade or floor is higher than the exterior grade. Without the explanation, NFIP flood insurance premiums may be higher than necessary.

INTERIOR GRADE OR FLOOR ABOVE BFE

When the interior grade or floor of an enclosure below an elevated building is entirely above the BFE, flood openings are recommended but not required. When the floor of an enclosure is above the BFE, the NFIP flood insurance policy will be rated using the enclosure floor as the lowest floor rather than the next higher floor above the enclosure. Installing flood openings in these situations will result in lower NFIP flood insurance premiums.

8.3.2 Sloping Sites

Buildings on solid perimeter foundation walls set into sloping sites present a special situation for the installation of flood openings. Careful attention must be paid to the following:

- The interior grade or floor along the lowest side of the building must be at or above the exterior grade across the entire length of the lowest side, and there must be positive surface drainage away from the building; otherwise, the enclosure will be considered a basement as defined by the NFIP.
- The bottom of each opening must be no higher than 1 foot above the exterior or interior grade immediately below the opening, whichever is higher (see Figure 13).
- For flood openings to perform their intended function, they should be below the BFE.

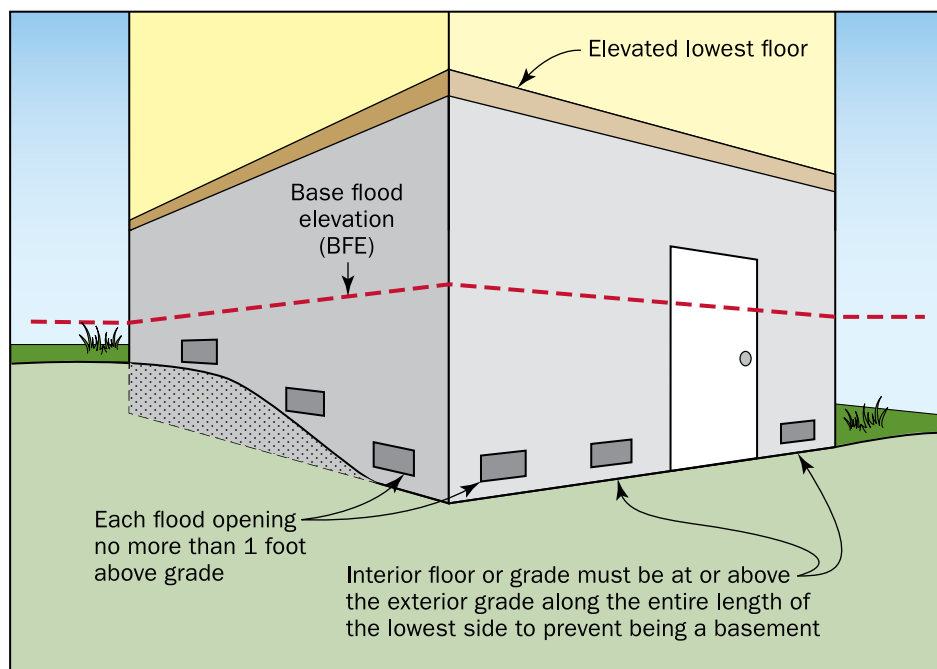

Figure 13: Flood openings in enclosure walls on a sloping site

- Interior partitions and load-bearing walls must have openings to allow water to readily reach every enclosed area (see Section 8.3.5 for information on buildings with multiple enclosures).

8.3.3 Buildings with Large Enclosed Areas

Some buildings, especially commercial and industrial buildings, have large under-floor spaces, crawlspaces, or enclosures. Flood openings may be stacked or grouped (see Figure 14), or large-dimension openings may be used, provided all of the requirements for openings are satisfied. Vertically stacked or closely spaced openings function together as one opening, and the bottom of the lowest opening must be no higher than 1 foot above the exterior grade or interior grade, whichever is higher.

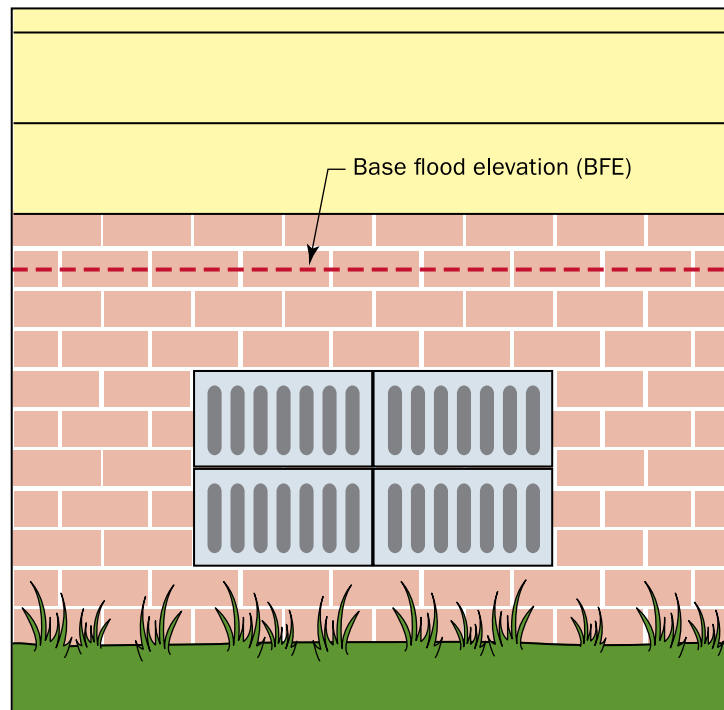

Figure 14: Flood openings that are stacked and closely grouped to satisfy the required total net open area

8.3.4 Townhouses with Limited Exterior Walls

Townhouses are single-family dwelling units constructed in groups of three or more attached units in which each unit extends from foundation to roof with exterior walls on at least two sides. Flood openings are required for townhouses in SFHAs that are constructed with solid perimeter foundation walls or solid walls surrounding enclosed areas under the elevated portion of the building.

Because interior townhouse units have less linear exterior wall length than end units, meeting all of the requirements for flood openings can be a challenge, especially the requirement for adequate opening area and the requirement that each enclosed area have openings. If openings cannot be provided in at least two exterior walls of each enclosed area, the NFIP allows all openings to be installed in one wall.

The design of interior townhouse units can satisfy the guidance that openings should be located on different sides of each enclosed area if interior partitions and walls have openings to connect enclosed spaces from front to back. Figure 15 shows suggested locations for openings. Note that the number of openings in Figure 15 is for illustration purposes only; the total number of openings and the adequacy of the opening area depend on the type of opening and whether non-engineered or engineered openings are installed. Fire-safety limitations generally preclude openings in the walls that separate townhouse units.

Providing adequate openings in enclosures below elevated townhouse units, other than end units, may be even more challenging if a multi-unit building is set into a sloping site. In this case, it may be appropriate to consider an open foundation or a backfilled stem wall foundation that does not require openings.

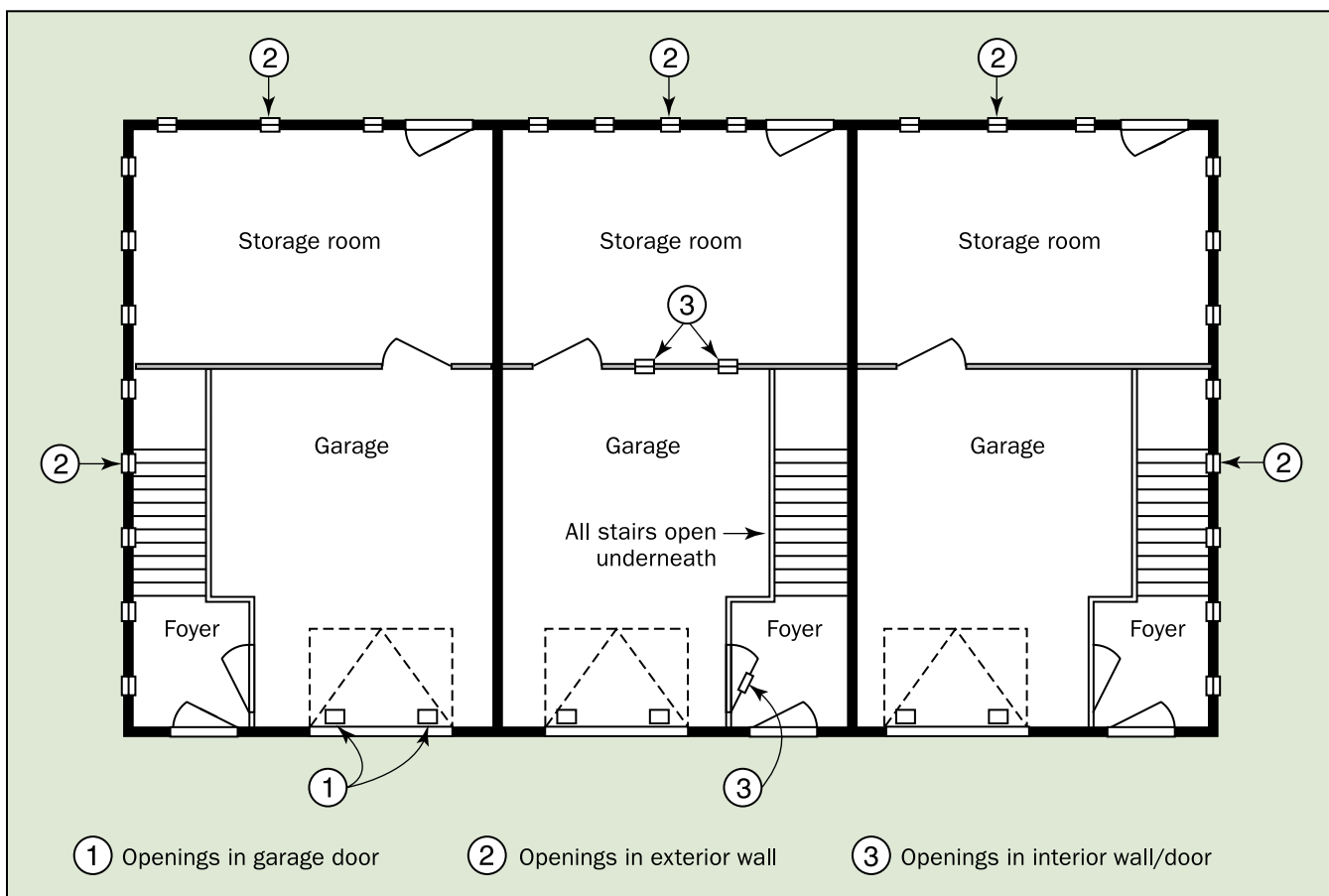

Figure 15: Suggested flood openings in enclosures under elevated townhouses (number of openings for illustration purposes only)

8.3.5 Buildings with Multiple Enclosures

Every enclosed area is required to meet the requirements for enclosures, including the requirement for flood openings in exterior walls. Figure 11 in Section 8.1 shows a home foundation plan with multiple enclosures. In some situations, openings in interior walls or partitions may be necessary to ensure that floodwater can reach all areas to minimize unbalanced hydrostatic loads on load-bearing interior walls and exterior walls (see middle townhouse in Figure 15 in Section 8.3.4). When openings are used in

interior walls, the total number of openings in exterior walls and the total opening area should be based on the size of the entire enclosed area. Openings in interior walls do not count toward the total opening requirements based on the exterior measurement of the enclosed area.

8.3.6 Flood Openings in Areas with Shallow Flooding

Some FIRMs show mapped SFHAs where the depth of floodwater above grade will be shallow (2 feet or less during the base flood). Shallow flooding occurs toward the landward boundary of SFHAs and in areas identified as being subject to sheet flow or ponding. The NFIP regulations require flood openings in enclosures even if the depth of flooding is only 1 foot and the difference in water depth between the inside and outside of enclosures is 1 foot or less.

NFIP ELEVATION CERTIFICATE AND SHALLOW FLOODING

The NFIP Elevation Certificate requires users to input the number of flood openings within 1.0 foot above the adjacent grade or floor. The certificate does not require users to determine how much of a flood opening is above or below the BFE.

Depending on the depth of floodwater in areas with shallow flooding, flood openings may extend above the BFE if the bottom of the opening is no higher than 1 foot above the higher of the final interior grade or floor and the finished exterior grade of the crawlspace or enclosure. When flood openings extend above the BFE, alternatives to satisfy the requirements include:

- Raise the floor of the enclosure to be at or above the BFE, perhaps by using a thicker slab, resulting in no need for openings. Although this alternative satisfies the construction requirement, for NFIP flood insurance rating purposes, the top of the slab is the elevation of the lowest floor, not the next higher floor (see the text box “Interior Grade or Floor above BFE” in Section 8.3.1).
- Install openings as close to grade (or floor) as possible to maximize the open area available for inflow and outflow of floodwater (see Figure 16). The total net open area of the openings must be based on the enclosed area even if some portion of the opening is above the BFE.

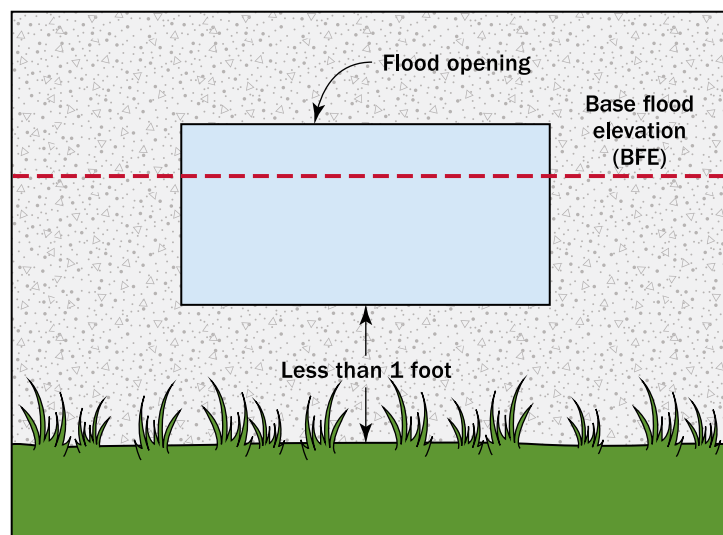

Figure 16: Bottom of the flood opening positioned as close as possible to grade (or floor) when any portion of the opening extends above the BFE

9 Non-Engineered Flood Openings and Engineered Flood Openings

The NFIP regulations, described in previous sections, identify options for providing sufficient size and number of flood openings to allow for the automatic (free) entry and exit of floodwater. This section describes how the automatic entry and exit of floodwater can be accomplished by the use of:

- Non-engineered openings that meet the prescriptive requirement to provide 1 square inch of net open area for each square foot of enclosed area, where the enclosed area is measured on the exterior of the enclosure walls. Section 9.2 describes a variety of options that can serve as non-engineered openings.
- Engineered openings for which Evaluation Reports are issued by the ICC Evaluation Service (ICC-ES), a subsidiary of the ICC, or equivalent reports issued by other product certification organizations.
- Engineered openings designed and certified by a registered design professional for a specific building and site-specific conditions.

All of the following requirements for installation apply regardless of whether engineered openings or non-engineered openings are used to satisfy the NFIP requirements (also see Section 8):

- Each enclosed area must have a minimum of two openings. When multiple enclosed areas are present, each area must have openings in its exterior walls. Section 8.3.5 describes connecting multiple areas by installing openings in interior walls or partitions to ensure that floodwater can reach all enclosed areas.
- The bottom of each opening must be no more than 1 foot above the higher of the final interior grade or floor or the finished exterior grade immediately under the opening.
- Insect screens, grates, grilles, fixed louvers, blades, faceplates, or other devices, if any, must not block the automatic flow of floodwater into and out of the enclosed area.

Section 9.1 provides a list of measures that are not acceptable as flood openings.

I-CODE REQUIREMENTS FOR FLOOD OPENINGS

The IRC includes requirements for non-engineered and engineered flood openings, and the IBC includes the same requirements by reference to ASCE 24.

FLOOD DAMAGE-RESISTANT MATERIALS

Flood openings must be made of flood damage-resistant materials in order to satisfy the requirement that materials used below the BFE be resistant to flood damage. Metals should be corrosion resistant, and plastics should be weather resistant. For guidance, see NFIP Technical Bulletin 2, *Flood Damage-Resistant Materials Requirements*.

9.1 Measures Not Acceptable as Flood Openings

FEMA has determined that the following measures do not satisfy the requirements for flood openings:

- Standard foundation air-ventilation devices that can be closed manually unless they are permanently disabled in the open position because otherwise, they do not allow for the automatic entry and exit of floodwater (see Figure 17).
- Standard foundation air-ventilation devices that have detachable solid covers intended to be manually installed over the vent because they do not allow for the automatic entry and exit of floodwater when the cover is in place.
- Standard foundation air-ventilation devices that are designed to open and close based on temperature unless they are also designed to allow for the automatic entry and exit of floodwater.
- Devices with covers or panels that are intended to displace when floodwaters rise on only one side of a wall because they do not satisfy the requirement for automatic entry and exit of floodwater in both directions.
- Windows below the BFE because the automatic entry and exit of floodwater cannot be satisfied by the expectation that windows will break under rising floodwater.
- Garage doors without openings because human intervention is required to open garage doors when flooding is expected. Gaps between the garage door and the door jamb or walls do not count toward the net open area requirement.



Figure 17: Standard air vent that is unacceptable as a flood opening because it is not disabled in the open position

9.2 Non-Engineered Flood Openings

Flood openings without moving parts are non-engineered openings, while those with moving parts should be certified as engineered openings (see Section 9.3). Non-engineered openings are used to provide 1 square inch of net open area for each square foot of enclosed area. The size of an enclosed

area in square feet should be measured on the exterior of the enclosure walls. A variety of non-engineered opening options are available.

“Net open area” refers to the permanently open area of a non-engineered opening. The NFIP regulations indicate that flood openings may be equipped with “coverings or devices” if they permit the automatic (free) entry and exit of floodwater in both directions.

The measurement of the net open area must take into consideration any solid obstructions such as grilles, fixed blades and louvers, or faceplates. Methods used by the ventilation industry to account for such obstructions when determining net open area for air flow may be used. Figure 18 shows a typical standard air-vent faceplate and measurements of the net open area. Figure 19 shows a typical ventilation louver with fixed blades and indicates how the net open area is determined.

Some manufacturers of standard air vents stamp the number of square inches the device provides for air flow into the frame of the device or may note the number in the packaging. The measurement accounts for

MEASUREMENT MUST ACCOUNT FOR OBSTRUCTIONS

Section C2.7.2.1 of the ASCE 24 commentary emphasizes that the measurement of net open area is not based on the dimensions of the opening (void) in the wall. The measurement must account for any portion of the void that is obstructed or covered in any way (other than by screening).

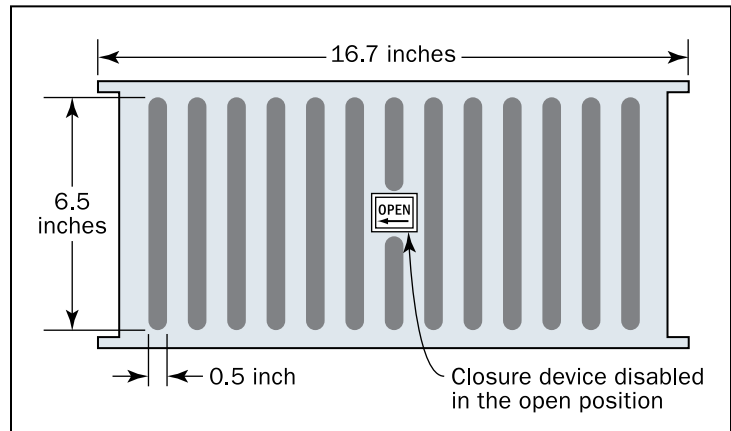

Figure 18: Example of non-engineered opening: Typical standard air vent faceplate providing 42 square inches of net open area if disabled in the open position; measurement of net open area uses a slot width of 0.5 inch times a slot height of 0.65 inch times the total number of slots

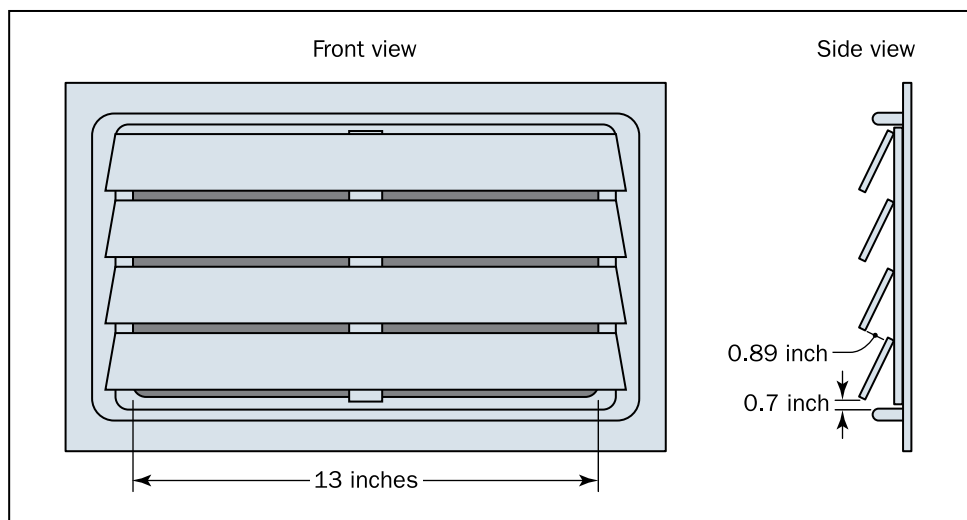

Figure 19: Example of non-engineered opening: Typical standard air vent with fixed, angled blades providing approximately 44 square inches of net open area; measurement of net open area uses slot width of 13 inches times the sum of the spaces between the blades

the presence of fixed blades, insect screens, and other obstructions. The same number of square inches should be used for the net open area calculation when these devices are installed as non-engineered openings. If not indicated by the manufacturer, the net open area must be measured. Guidance on measuring the net opening area may be available from manufacturers or other sources.

To qualify as non-engineered flood openings that permit the automatic entry and exit of floodwater:

- Standard air vents must not have solid covers (detachable or integrated with the vent) that are intended to be manually installed.
- Typical air-vent devices that are designed to be opened and closed manually must be disabled permanently in the open position.
- Air-vent devices that are designed to open and close based on temperature must also be designed to allow the automatic entry and exit of floodwater.

Insect screens that do not block the entry and exit of floodwater are allowed and do not affect the determination of the net open area. Communities that administer the IBC or IRC should note the requirement to cover ventilation openings for crawlspaces and under-floor spaces. The codes provide a list of acceptable covering materials.

The IBC and IRC commentaries note that some covering materials for ventilation openings may reduce the gross open area of the vent by as much as 50 percent. Although the net open area is not reduced by screens, in areas where floodwater is expected to carry debris such as grass clippings and leaves, insect screens tend to clog (see Figure 20).

Engineers, architects, and local officials may determine that a different type of opening is appropriate or that more than the minimum number of flood openings is required to increase the likelihood that openings will perform as expected during flooding, even if some of them become clogged with debris.

AREAS LIKELY TO HAVE DEBRIS AND SEDIMENT

Section C2.7.2.1 of the ASCE 24 commentary suggests using caution in selecting or specifying openings with louvers, blades, screens, or faceplates that may be blocked by debris and sediment. In areas where experience indicates that floodborne debris and sediment are likely, ASCE 24 recommends avoiding the use of openings with components that have been shown to become blocked or clogged.



Figure 20: Typical air vents with insect screens blocked by flood debris

Examples of non-engineered openings are described below and shown in Figures 21 through 24.

- Figure 21 shows typical standard air-ventilation devices that are intended for crawlspace foundation walls. If installed as flood openings, they must be disabled permanently in the open position to satisfy the requirement for automatic entry and exit of floodwater.
- Figure 22 shows decorative masonry units and decorative brickwork with closely spaced, open holes. Only the net open area of each hole is counted.
- Figure 23 shows standard concrete blocks that are turned sideways and have insect screening. The voids in the blocks are measured to determine the net open area.
- Figure 24 shows a foundation in which a hole was created when the concrete was poured. The horizontal dimension should be greater than the vertical dimension to facilitate flow-through. A wood frame covered with insect screening is inserted into the hole. The framed void is measured to determine the net open area. A similar situation results when a block is omitted from perimeter foundation walls constructed of concrete masonry units, resulting in a void the size of the omitted block.

MINIMUM DIMENSION SPECIFIED BY I-CODES

The IRC and IBC (by reference to ASCE 24) require that openings be not less than 3 inches in any direction in the plane of the wall. This requirement applies to the opening in the wall, excluding any device that may be inserted.

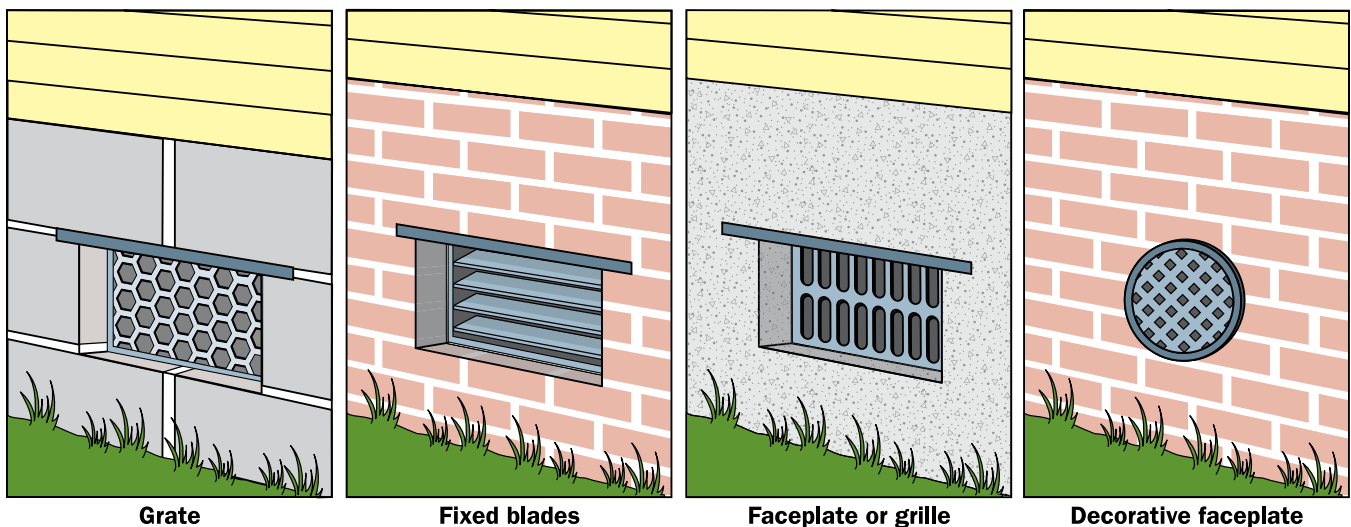

Figure 21: Examples of typical air vents in crawlspace foundation walls used as flood openings with varying net open areas

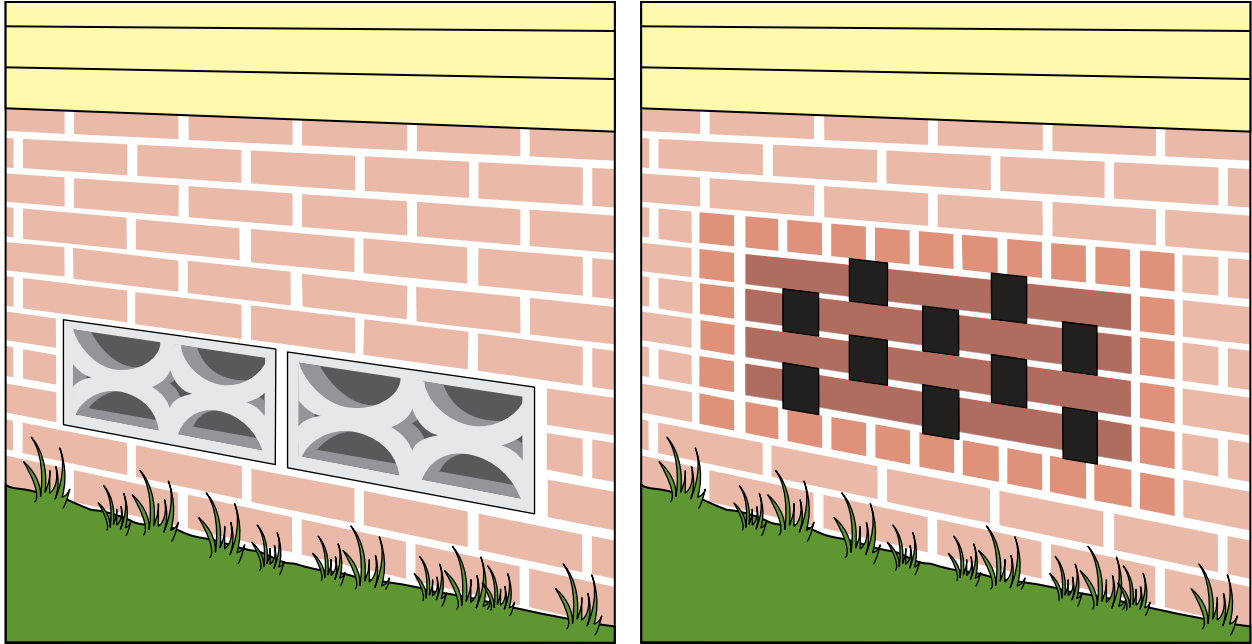

Figure 22: Decorative masonry units and closely spaced holes in brickwork; the area of each hole counts toward the total net open area

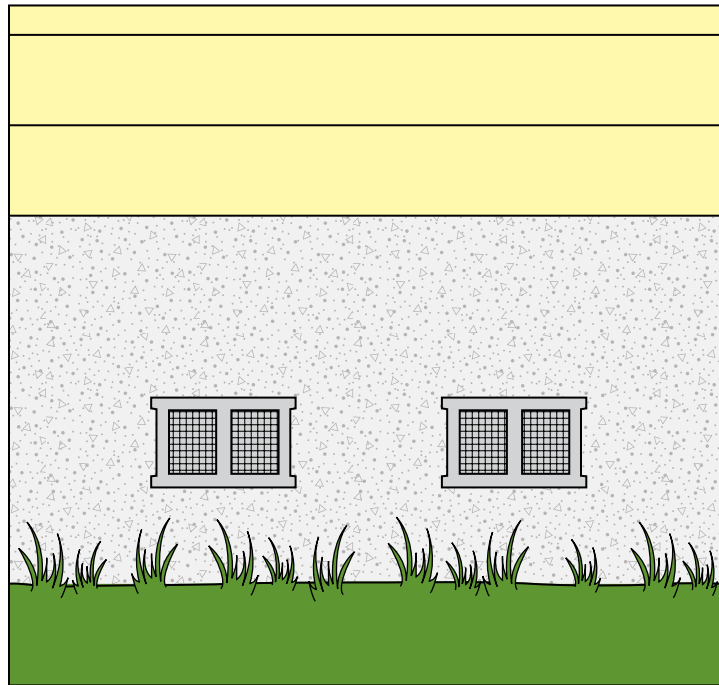

Figure 23: Concrete blocks turned sideways with insect screening; a typical 8- by 16-inch block provides approximately 60 square inches of net open area

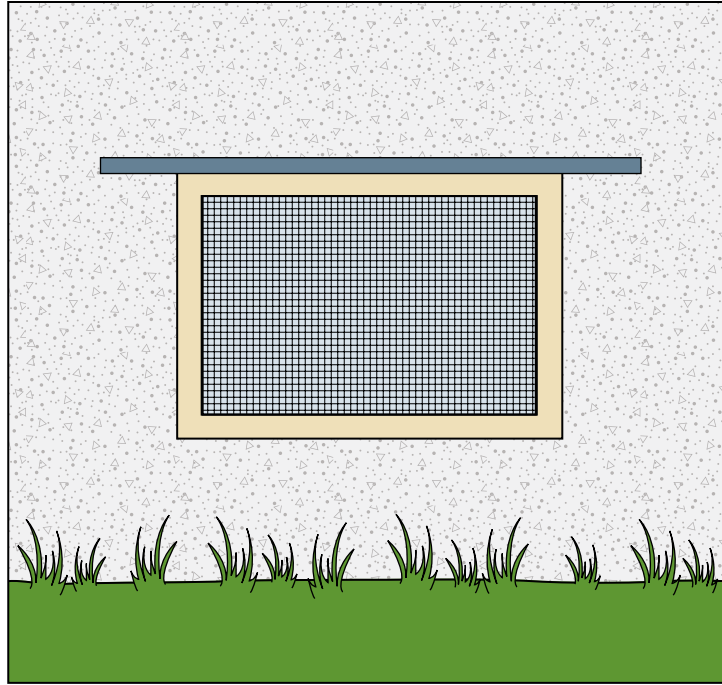

Figure 24: Wood frame with insect screen inserted in void in poured concrete foundation wall; inside dimensions of frame determine net open area

9.3 Engineered Flood Openings

Engineered flood openings, which have moving parts, must be designed and certified by registered design professionals as engineered flood openings (see Section 9.2 for openings without moving parts). The certification must specifically address the performance required by the NFIP regulations. Devices with moving parts should be certified as engineered openings. In general, engineered openings remain closed until flood conditions trigger the movable parts to allow floodwater and debris to freely and automatically enter or exit. This section describes the design and performance requirements and the certification and documentation requirements for engineered openings.

9.3.1 Design and Performance Requirements

The design and performance criteria for engineered openings are in ASCE 24, Section 2.7.2.2. Section C2.7.2.2 of the ASCE 24 commentary provides additional information on engineered openings and the best means to test expected performance.

The equation from ASCE 24, shown in Figure 25, is used to determine the total net area of engineered openings required for a given total enclosed area, based on some of the characteristics of the openings. The calculated minimum net area of engineered openings may be called the “coverage” or “rated” area.

$$A_o = 0.033 [1/c] R A_e$$

Where: A_o = total net area of openings required (in²)
0.033 = coefficient corresponding to a factor of safety of 5.0 (in² • hr/ft³)
 c = opening coefficient (non-dimensional; see ASCE 24, Table 2-2)
 R = worst case rate of rise and fall (ft/hr)
 A_e = total enclosed area (ft²)

Figure 25: Equation used to determined total net area of engineered openings (ASCE 24-14; used with permission)

The equation includes a coefficient (0.033) that corresponds to a factor of safety of 5, which is consistent with design practices related to the protection of life and property. The ASCE 24 commentary provides additional background on the derivation of the equation.

Design and performance criteria for engineered openings specified in ASCE 24 include all of the following:

- Performance must allow for the automatic entry and exit of floodwater. The ASCE 24 commentary notes that the certification requires consideration of a number of factors that represent expected base flood conditions and not simply application of the equation. (Flood conditions in different areas can vary widely; in some areas, the onset of flooding may be rapid while in other areas, flood conditions may develop over much longer periods.)
- Performance must account for the presence of obstructions such as louvers, blades, screens, grilles, faceplates, and devices that are part of the engineered opening assembly itself. In accordance with ASCE 24, Table 2-2 (see Table 3 of this Technical Bulletin), the opening coefficient of discharge (c) is 0.20 for openings of all shapes if partially obstructed during design flood conditions by “louvers, blades, screens, grilles, faceplates, or other covers or devices [that] are present during the design flood,” as opposed to blocked by debris.

ASCE 24 EMPHASIS ON PERFORMANCE AND CERTIFICATION

Engineered opening requirements changed between the 2005 and 2014 editions of ASCE 24. The 2014 edition places more emphasis on evidence of performance and consideration of factors that represent expected flood conditions. Section C2.7.2.2 of the ASCE 24-14 commentary notes that the best means to certify performance is to test engineered openings under conditions that mimic a range of rates of rise and fall, including rates many times the minimum rate of 5 feet per hour.

Documentation of performance under faster rates of rise and fall provides building designers and local officials with sufficient information on which to base decisions regarding whether to increase the number or size of openings to account for faster rates. The ASCE 24 commentary also notes that testing should be done with water containing debris typical of flooding around buildings (e.g., leaves, grass clippings, small branches, trash).

(The coefficient of discharge, also called an orifice coefficient, is selected to characterize the shape of the portion of an engineered opening through which water flows.)

Table 3: Flood Opening Coefficient of Discharge⁽¹⁾

Opening Shape and Condition	c
All shapes, partially obstructed during design flood ⁽²⁾	0.20
Circular, unobstructed during design flood	0.60
Rectangular, long axis horizontal, short axis vertical, unobstructed during design flood	0.40 ⁽³⁾
Square, unobstructed during design flood	0.35
Rectangular, short axis horizontal, long axis vertical, unobstructed during design flood	0.25 ⁽⁴⁾
Other shapes, unobstructed during design flood	0.30

Source: ASCE 24-14, Table 2-2 (used with permission)

- (1) Different coefficients of discharge shall be permitted: (1) where a designer has performed detailed, opening-specific calculations, a coefficient of discharge up to 10% different than given in Table 2-2 shall be permitted; or (2) where laboratory testing or numerical modeling of flow through the opening has been conducted, the resulting coefficient of discharge shall be permitted. In no case shall a coefficient of discharge >0.60 be permitted.
- (2) Openings shall be classified as partially obstructed if louvers, blades, screens, grilles, faceplates, or other covers or devices are present during the design flood.
- (3) When the horizontal dimension is twice or more the vertical dimension, use 0.4; as the dimensions approach a square, interpolate from 0.4 to 0.35.
- (4) When the horizontal dimension is half or less the vertical dimension, use 0.25; as the dimensions approach a square, interpolate from 0.25 to 0.35.

- Performance must account for the potential for debris blockage even if there are no louvers, blades, screens, grilles, faceplates, or other devices, preferably by allowing typical floodborne debris to pass through.
- Performance must ensure that the difference between the exterior and interior water levels will not exceed 1 foot. (Because the minimum requirement allows the bottom of openings to be no more than 1 foot above the higher of the finished interior grade [or floor] or exterior grade, a difference of no more than 1 foot is maintained when water begins to pass through as it crests the bottom of the opening frame.)
- The minimum dimension of an opening in a wall must not be less than 3 inches in any direction in the plane of the wall.
- Reliable data on the rates of rise and fall at specific locations are usually not readily available. Therefore, engineered openings must be designed and must function based on the assumption that the minimum rate of rise and fall will be 5 feet per hour. Reinforcing the importance of testing for

FLOODWATER RATE OF RISE AND FALL

Section C2.7.2.2 of the ASCE 24 commentary notes that a rate of rise of 5 feet per hour, only 1 inch per minute, is not representative of many flood hazard areas and advises building designers to be cautious about relying entirely on that rate. Faster rates of rise and fall are likely in watersheds where rainfall runoff accumulates rapidly and in many areas that are subject to storm surge flooding. ASCE 24 advises that information on rates of rise may be available from stream and tide gauges; federal, state, and local sources; and video documentation of past flood events.

faster rates of rise and fall, building designers must increase the specified total net area of engineered openings when site-specific data or analyses of anticipated flood conditions indicate that more rapid rates of rise and fall are likely.

9.3.2 Documentation of Engineered Openings for Compliance

Engineered openings should be accepted by local officials when the designs are certified and the certifications are submitted as part of permit applications. Acceptable documentation of certification are the certification reports (i.e., ICC-ES Evaluation Reports or equivalent reports from other product certification organizations) and individual certifications for specific buildings (see Section 9.3.4).

Copies of the certifications must be kept in the community’s permanent permit files. Community retention of these documents is important not only to demonstrate compliance but also in the event that future building owners do not receive copies of the certifications when they buy buildings. Owners must submit certifications with applications for NFIP flood insurance policies.

I-CODES REQUIRE DESIGN STATEMENTS

The IBC and IRC require that construction documents submitted for building permits include design statements by registered design professionals when applicants propose using engineered openings. ICC-ES Evaluation Reports and equivalent certification reports satisfy this requirement.

Individual certifications prepared for specific buildings also satisfy the requirement for design statements.

9.3.3 Engineered Openings with Certification Reports

The ICC-ES and other product certification organizations develop criteria for acceptance of a variety of building products, construction methods, and materials. Each organization issues certification reports after technical evaluation of documentation that is submitted by manufacturers. Documentation typically includes technical design reports, certifications, and testing results to demonstrate performance and compliance with codes and standards. Certification reports provide evidence that products comply with specific building codes and standards. Designers, builders, and local officials who rely on these reports must determine whether the reports identify the editions of the building codes and ASCE 24 that are applicable to individual projects. If applicable editions of the codes and standard are not identified, the certification report should not be used.

Documentation submitted by manufacturers to obtain an ICC-ES Evaluation Report or equivalent certification report for engineered openings must be supported by certifications describing the performance of the openings and the name, title, address, type of license, license number, the state in which the license was issued, and the signature and seal of the certifying registered

SITE-SPECIFIC APPLICABILITY OF ENGINEERED OPENINGS

When an engineered opening product with a certification report issued by ICC-ES or an equivalent product certification organization is specified in construction documents, the engineer, architect, or builder should determine whether the product, given its limitations and conditions of use, is appropriate for the conditions of flooding at the site, especially the rate of rise and fall of floodwater. Designers should consult with local officials regarding observations of past rates of rise and fall during conditions of flooding.

design professional. The certification reports must include a description of installation requirements or limitations that, if not followed, would void the certification. FEMA considers the following documentation important:

- Statement certifying that the openings, when properly installed, are designed to automatically equalize hydrostatic flood loads on exterior walls by allowing the automatic entry and exit of floodwater in accordance with the design and performance requirements in ASCE 24.
- Statement certifying that the performance accounts for the presence of louvers, blades, screens, grilles, faceplates, or devices with consideration of the potential for debris blockage when these features are present.
- Description of the measurement of the actual net area of the engineered opening that is being certified and identification of the opening coefficient of discharge, which is the variable c in the formula in ASCE 24 (see Figure 25 and Table 3 of this Technical Bulletin). The coefficient of discharge is selected by the designer based on the shape and dimensions of the opening and whether the engineered opening has features such as louvers, blades, screens, grilles, faceplates, or devices that partially obstruct flow during conditions of flooding.
- The range of flood characteristics tested for which the certification is valid, specifically the rates of rise and fall of floodwater, which is the variable R in the formula in ASCE 24 (see Figure 25), and whether there are any limitations based on rates of rise and fall that are faster than 5 feet per hour. Given the ASCE 24 performance expectations, engineered openings must function during conditions of the minimum 5 feet per hour rate of rise and fall.

9.3.4 Engineered Openings Individually Certified for Specific Buildings

Engineered openings that do not have ICC-ES Evaluation Reports or equivalent certification reports must be individually certified as meeting the design requirements described in Section 9.3.1 of this Technical Bulletin and for acceptability in specific buildings based on site-specific conditions. The formula in Section 9.3.1 includes the variable R , which is the worst-case rate of rise and fall at a specific location. ASCE 24 allows the assumption of a minimum rate of rise and fall of 5 feet per hour only in the absence of reliable data on site-specific rates of rise and fall. Building designers who specify engineered openings that are individually certified should consult local officials regarding observations of past rates of rise and fall during conditions of flooding.

Generic certifications for manufactured products place the burden on users (who may not be design professionals) to determine whether a specific location is subject to rates of rise and fall greater than 5 feet per hour. For this reason, generic “fill-in-the-blank” certifications are not acceptable when a manufactured product is used for a specific building unless the builder or design professional for that building, or the local official, determines that the rates of rise and fall at the specific location are no faster than 5 feet per hour. Alternatively, the builder or design professional may submit documentation that there are no reliable data for site-specific rates of

INDIVIDUAL CERTIFICATION FOR SPECIFIC BUILDINGS MUST ADDRESS SEVERAL FACTORS

Section C2.7.2.2 of the ASCE 24 commentary indicates that “certification requires more than simply applying the equation ... it requires consideration of a number of factors that represent expected base flood conditions.” The commentary also notes that engineered openings should be tested unless uniquely designed for a specific location.

rise and fall, in which case the local official may concur that the rates may be assumed to be no faster than 5 feet per hour.

When engineered openings that have been individually certified for specific buildings are used, the permit application must include a certification that is signed and sealed by the registered design professional, who must be licensed to practice in the state in which the building is located. In addition, the submitted plans must identify the location for the openings and specify installation instructions.

The original certification for engineered openings prepared for specific buildings must include the design professional's name, title, address, signature, type of license, license number, the state in which the license was issued, and the signature and applied seal of the certifying registered design professional. The original certification must identify the physical location of the building in which the engineered openings will be installed.

This Technical Bulletin relies on the ASCE 24 requirements for engineered openings as the accepted standard of practice. The certification must include a description of installation requirements or limitations that, if not followed, will void the certification. In addition to the design and certification criteria listed in Section 9.3.1, the certification must include the following:

- Statement certifying that the openings, when properly installed, are designed to automatically equalize hydrostatic flood loads on exterior walls by allowing the automatic entry and exit of floodwater in accordance with the design and performance requirements in ASCE 24.
- Statement certifying that the performance accounts for the presence of louvers, blades, screens, grilles, faceplates, or devices with consideration of the potential for debris blockage when these features are present.
- Description of the measurement of the actual net area of the engineered opening and identification of the opening coefficient of discharge, which is the variable c in the formula in ASCE 24 (see Figure 25 and Table 3 of this Technical Bulletin). The coefficient of discharge is selected by the designer based on the shape and dimensions of the opening and whether the engineered opening has features such as louvers, blades, covers, screens, grilles, faceplates, or other elements that partially obstruct flow during conditions of flooding.
- Determination of the rate of rise and fall of floodwater at the site and a statement certifying that the openings are designed for that rate of rise and fall or a statement that the opening is designed for a minimum rate of rise and fall of 5 feet per hour because reliable data on site-specific rates of rise and fall are not available.

9.3.5 NFIP Elevation Certificate and Documentation of Engineered Openings for Flood Insurance

When engineered openings are used, the NFIP Elevation Certificate must be completed carefully. The question “Engineered flood openings?” must be answered with “Yes” (see A8.d and A9.d in Figure 26). The engineered opening documentation must be attached to the NFIP Elevation Certificate. Insurers and insurance agents must ask property owners to provide the documentation as part of applications for NFIP flood insurance policies. The following are acceptable forms of documentation:

- For engineered openings with ICC-ES Evaluation Reports or equivalent reports from other product certification organizations, a copy of the report that identifies the manufacturer’s model number and specifies the number of such openings that are required for a specified square footage of enclosed area
- For engineered openings individually certified for installation in a specific building, a certification that is signed and sealed by a registered design professional who is licensed in the state where the building is located, and that addresses the statements described in Section 9.3.4

NFIP ELEVATION CERTIFICATES AND NON-ENGINEERED OPENINGS

When non-engineered openings are used, the total net open area of the openings that are within 1.0 foot above the higher of the exterior or interior grade or floor should be determined by measurement (see examples in Section 9.2) or by using the manufacturer’s specifications.

To complete the NFIP Elevation Certificate with information required for proper rating of NFIP flood insurance policies for buildings with engineered openings, Item A8.c, “Total net area of flood openings in A8.b,” must be filled in with the total coverage or rated area of engineered openings. The total coverage or rated area is the number of engineered openings identified in Item A8.b multiplied by the “coverage” area, “rated” area, or “enclosed area coverage” identified in the ICC-ES Evaluation Report, equivalent report, or individual certifications. When engineered openings are used in attached garages, Item A9.c must be completed in the same manner. The coverage or rated area usually is given in square feet of enclosed area for which an engineered opening can provide automatic inflow and outflow of floodwater, which is, in effect, equivalent to the performance that would be provided by that number of square inches of non-engineered openings.

Also, in Section D, “Check here if attachments” must be selected, and a copy of the certification report must be attached to the NFIP Elevation Certificate (see Figure 26). Notes must be added in the Section D comment section to identify the manufacturer and the manufacturer’s model number of the engineered opening.

A8. For a building with a crawlspace or enclosure(s):

a) Square footage of crawlspace or enclosure(s) 1,675 sq ft

b) Number of permanent flood openings in the crawlspace or enclosure(s) within 1.0 foot above adjacent grade 9

c) Total net area of flood openings in A8.b 1,800 sq in

d) Engineered flood openings? Yes No

A9. For a building with an attached garage:

a) Square footage of attached garage 350 sq ft

b) Number of permanent flood openings in the attached garage within 1.0 foot above adjacent grade 2

c) Total net area of flood openings in A9.b 400 sq in

d) Engineered flood openings? Yes No

Insert coverage/rated area times number of engineering openings in A8.b and A9.b. Add comments to identify engineering openings and attach copy of Evaluation Report or certification

Comments (including type of equipment and location, per C2(e), if applicable)

A8 and A9 – Engineered openings manufactured by XXX Company, Inc., model number XX-XXX, ICC-ES Report No. XXXX (attached). Rated 200 sq in per unit.

FEMA Form 086-0-33 (7/15) Replaces all previous editions. Form Page 1 of 6

Figure 26: Completing the NFIP Elevation Certificate when engineered openings are used

10 References

This section lists the references cited in this Technical Bulletin. Additional resources related to NFIP requirements are provided in Technical Bulletin 0.

ASCE/SEI. 2014. ASCE/SEI 24-14, *Flood Resistant Design and Construction*. Available at <https://www.asce.org/>.

FEMA (Federal Emergency Management Agency). Various NFIP Technical Bulletins. Current editions are available at <https://www.fema.gov/nfip-technical-bulletins>:

- Technical Bulletin 0, *Users Guide to Technical Bulletins*.
- Technical Bulletin 2, *Flood Damage-Resistant Materials Requirements*.
- Technical Bulletin 3, *Non-Residential Floodproofing – Requirements and Certification*.
- Technical Bulletin 7, *Wet Floodproofing Requirements for Certain Buildings Located in Special Flood Hazard Areas*.
- Technical Bulletin 9, *Design and Construction Guidance for Breakaway Walls*.
- Technical Bulletin 11, *Crawlspace Construction for Buildings Located in Special Flood Hazard Areas: National Flood Insurance Program Interim Guidance*.

FEMA. 2004. FEMA 467-1, *Floodplain Management Bulletin: Elevation Certificate*. Available at <https://www.fema.gov/media-library/assets/documents/3539>.

FEMA. 2010. FEMA P-758, *Substantial Improvement/Substantial Damage Desk Reference*. Available at <https://www.fema.gov/media-library/assets/documents/18562>.

FEMA. 2013. FEMA P-936, *Floodproofing Non-Residential Buildings*. Available at <http://www.fema.gov/media-library/assets/documents/34270>.

FEMA. 2015. FEMA Form 086-0-33, *NFIP Elevation Certificate and Instructions*. Available at <http://www.fema.gov/media-library/assets/documents/160>.

FEMA. 2018. FEMA 213, *Answers to Questions About Substantially Damaged Improved/Damaged Buildings*. Available at <https://www.fema.gov/media-library/assets/documents/169099>.

FEMA. 2019. *NFIP Flood Insurance Manual*. Available at <https://www.fema.gov/flood-insurance-manual>

ICC (International Code Council). International Codes. Available at <https://codes.iccsafe.org/category/I-Codes>.

- 2012 International Building Code
- 2012 International Residential Code
- 2015 International Building Code
- 2015 International Residential Code
- 2018 International Building Code
- 2018 International Residential Code

NFPA (National Fire Protection Association). 2017. NFPA 225, *Model Manufactured Home Installation Standard*. Available at www.nfpa.org.